

Thermal Switch

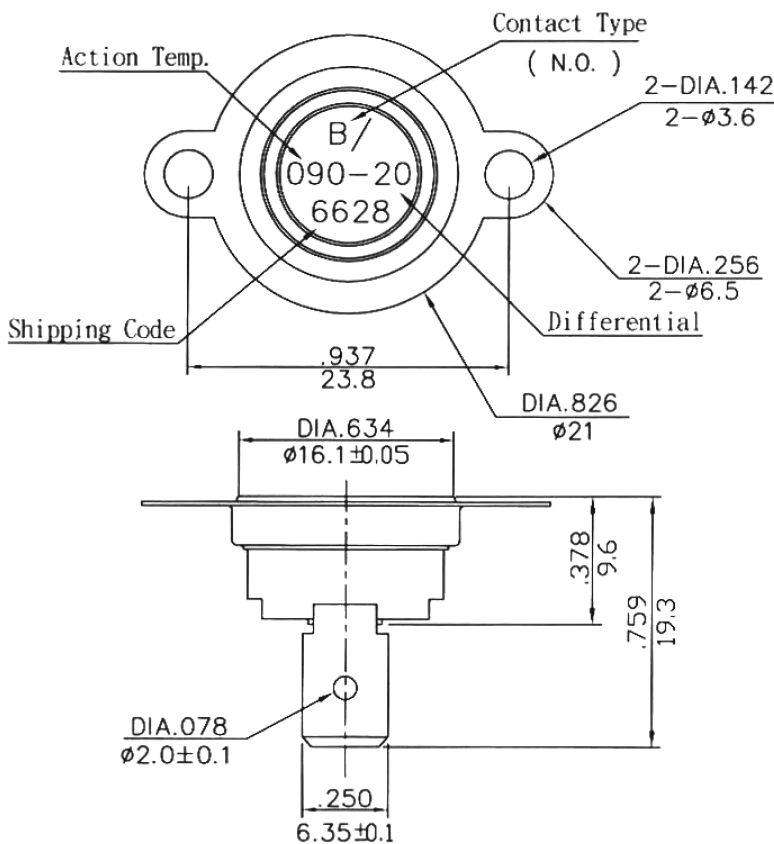

Specifications:

Contact Rating	: 250V AC / 16A, 240V AC / 15A
No. of Pins	: 2
Sensor Housing	: Plastic
Sensor Terminals	: Quick Connect
Actuating Temperature	: -70°C to +70°C
Contact Current Max.	: 10A
Contact Voltage Max.	: 250V AC
External Depth	: 17mm
External Length / Height	: 16mm
External Width	: 30mm
Fixing Centres	: 24mm
Material	: Thermoplastic
No. of Electrical Operations	: 100,000
Switch Operation	: Normally Open
Circuit Resistance	: 50mΩ Max.
Insulation Resistance	: 50MΩ min. at DC 500V
Dielectric Strength	: AC 1,000V for One Minute or AC 1,800V for One Sec.



Shipping Code

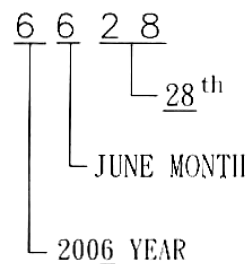

Dimensions : Millimetres (Inches)



Thermal Switch

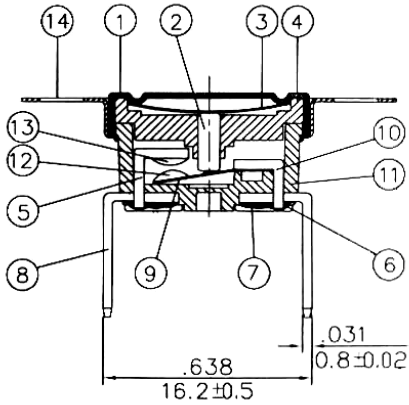

No	Part Name	Material
1	Sensing Cap	Aluminium
2	Actuating Pin	Ceramic
3	Bimetal Disc	Bimetal
4	Retainer	PPS
5	Stationary Arm	Brass Tin Plated
6	Solder	Tin
7	Glue	Epoxy
8	Terminal	Brass Tin Plated
9	Movable Arm	Beryllium Copper
10	Terminal-J	Brass Tin Plated
11	Case	PPS
12	Contact-R	Silver Alloy
13	Contact-F	Silver Alloy
14	Bracket	Steel Nickel Plated

Part Number Table

Description	Part Number
Thermal Switch, NO, 90°C	T23B090ASR2-20

Important Notice : This data sheet and its contents (the "Information") belong to the members of the Premier Farnell group of companies (the "Group") or are licensed to it. No licence is granted for the use of it other than for information purposes in connection with the products to which it relates. No licence of any intellectual property rights is granted. The Information is subject to change without notice and replaces all data sheets previously supplied. The Information supplied is believed to be accurate but the Group assumes no responsibility for its accuracy or completeness, any error in or omission from it or for any use made of it. Users of this data sheet should check for themselves the Information and the suitability of the products for their purpose and not make any assumptions based on information included or omitted. Liability for loss or damage resulting from any reliance on the Information or use of it (including liability resulting from negligence or where the Group was aware of the possibility of such loss or damage arising) is excluded. This will not operate to limit or restrict the Group's liability for death or personal injury resulting from its negligence. Multicomp is the registered trademark of the Group. © Premier Farnell plc 2012.

