

Amphenol AIT/MS Series MIL-DTL-5015



ENVIRONMENTALLY-SEALED FOR CHALLENGING ENVIRONMENTS

The MIL-DTL-5015 AIT/MS series is a cost-effective threaded circular connector for use in harsh environments. These Amphenol connectors are sealed to withstand moisture, condensation, vibration and flash-over. Over 286 contact layouts are available, in variations that allow for just power, just signal, or a mix of both contact types. Available in five mounting styles, nineteen shell sizes, and solder or crimp termination.

- Formerly MIL-C-5015

APPLICATIONS

Military, industrial and commercial environments requiring extreme reliability, high-power handling and cost efficiency.

- Power generators
- Engines
- Sensors
- Motion control
- Off-road vehicles
- Earth-moving equipment
- Ships
- Mobile equipment
- Industrial machinery
- Telecommunications

FEATURES

AGENCY APPROVALS

MIL-DTL-5015 (Formerly MIL-C-5015)

BROAD TEMPERATURE RANGE

These connectors will operate in temperatures ranging from -67°F to +257°F (-55°C to +125°C).

ENVIRONMENTAL

These connectors will perform in the full range of operating conditions as defined in MIL-DTL-5015 and are recommended for conditions where vibration, moisture, pressure and/or temperature are extreme.

RESILIENT INSULATOR AND GROMMET

A resilient neoprene insulator and rear-seal grommet provide a liquid-tight assembly.

RUGGED SHELL

The rugged aluminum alloy shell and hardware are light in weight yet highly resistant to damage and corrosion. Shells are available in five different styles and in 19 sizes.

WIDE RANGE OF WIRE GAUGES AND CURRENT CARRYING CAPACITY

Up to 150 amps for standard military contacts and up to 255 amps using Radsok® contacts. Wire gauges from 24 to size 0 AWG.

WIDE VARIETY OF CONTACTS

Machined contacts with silver or gold plating are available in sizes from 16 through 0. Solder, Crimp, PC, and thermocouple contacts are available.

**TECHNICAL
SPECIFICATIONS**
MATERIALS & FINISHES

Shell	Aluminum alloy
Plating	Olive drab chromate coating over cadmium plating to QQ-P-416; black alloy, conductive black alloy, electroless nickel, anodized or green zinc
Contacts	Brass or copper alloy
Platings	Silver plating to QQ-S-365 (solder contacts have tinned solder pot) Gold plating to MIL-G-45204
Insulator	Resilient Neoprene®, Viton®, low-smoke, zero-halogen (LSZH)

ELECTRICAL DATA

Operating Voltage/Test Voltage

MS SERVICE RATING	NOMINAL DISTANCE (IN.)		OPERATING VOLTAGE*		STANDARD SEA LEVEL CONDITIONS		PRESSURE ALTITUDE† 50,000 FEET		PRESSURE ALTITUDE† 70,000 FEET	
	AIRSPACE	CREEPAGE	DC V	AC VRMS	MINIMUM FLASHOVER VOLTAGE AC (RMS)	TEST VOLTAGE AC (RMS)	MINIMUM FLASHOVER VOLTAGE AC (RMS)	TEST VOLTAGE AC (RMS)	MINIMUM FLASHOVER VOLTAGE AC (RMS)	TEST VOLTAGE AC (RMS)
I	1/32	1/16	250	200	1,400	1,000	550	400	325	260
A	1/16	1/8	700	500	2,800	2,000	800	600	450	360
D	1/8	3/16	1,250	900	3,600	2,800	900	675	500	400
E	3/16	1/4	1,750	1,250	4,500	3,500	1,000	750	550	440
B	1/4	5/16	2,450	1,750	5,700	4,500	1,100	825	600	480
C	5/16	1	4,200	3,000	8,500	7,000	1,300	975	700	560

* Each insulator has a specific service rating. These should be used by the designer only as a guide.
The Service Ratings for each layout are listed on [pages 72-93](#).

† Not corrected for change in density resulting from variations in temperature

MS connectors show no evidence of breakdown when the given test voltages are applied between the two closest contacts and between the shell and the contacts closest to the shell for a period of one minute, per MIL-STD-1344 Method 3001.

Current Rating & Contact Resistance

CONTACT SIZE	TEST CURRENT (AMPS)	POTENTIAL DROP (MILLIVOLTS)	CONTACT RESISTANCE (MILLIOHM) MAX.
16	13	49	6
12	23 (50*)	42	3
8	46 (69*)	26 (20*)	1 (0.44*)
4	80 (80*)	23 (18*)	0.5 (0.23*)
0	150 (225*)	21 (27*)	0.2 (0.18*)

*Using non-military crimp Radsok contact

Maximum total current to be carried per connector in wire bundles as specified in MIL-W-5088.
Contact resistance when tested to MIL-C-39029 will not exceed voltage drops listed in above table.

Viton® is a registered trademark of Dupont Dow Elastomers

MECHANICAL

Wire Range Sizes	24 to 0 AWG (⇒ crimp contacts on pages 30-31)
Insulation Resistance	>5000 megohms at 77°F (25°C) per MIL-DTL-5015, 3.18
Wire Sealing Range	

CONTACT SIZE	WIRE SIZE (MIL-W-5086)	INSULATION OUTSIDE DIAMETER LIMIT			
		MIN.		MAX.	
		IN.	MM.	IN.	MM.
16	16 thru 20	.064	1.63	.130	3.30
12	12 thru 14	.114	2.90	.170	4.32
8	8 thru 10	.164	4.17	.255	6.48
4	4 thru 6	.275	6.98	.370	9.40
0	0 thru 2	.415	10.54	.550	13.97

The connector is designed for individual wire sealing. Sealing of an outer cable jacket on multiconductor cables must be accomplished with an appropriate endbell. Sealing is only guaranteed if wires according to MIL-W-5086 or within the listed ranges are used.

Insulation Strip Lengths	(⇒ see page 30)
Mating Life	100 cycles minimum, to MIL-DTL-5015, 3.16
Salt Spray	MIL-STD-1344 Method 1001 condition B minimum (cadmium), 48 hour, olive drab chromate over cadmium, non-conductive black alloy, conductive black alloy, green zinc, black anodized, electroless nickel
Heat	+257°F (+125°C) for 60 hours, +185°F (+85°C) for 1,000 hours per MIL-DTL-5015, 4.6.14, minimum
Chemical Resistance	20-hour full-immersion unmated in hydraulic fluid and lubricating oil per MIL-DTL-5015 minimum
Vibration	10 to 2,000Hz (10g's) 10 microseconds maximum discontinuity to MIL-STD-1344 Method 2005, condition II per MIL-DTL-5015
Shock	50g 11 millisecond duration, three major axes. 10 microseconds maximum discontinuity to MIL-DTL-5015 per MIL-STD-1344 method 2004, condition A, 3.13
Contact Type	Solder, crimp, PC, or thermocouple (hard silver or gold plating)
Number of Circuits	1 to 85 (⇒ See pages 72-82)
Contact Insertion	Insertion from rear with simple hand tool. Removable, five cycles minimum. (Solder, PC and coax outer housings are bonded into the insulator.)
Contact Retention	To MIL-DTL-5015, 4.6.6 & 3.26 and separation forces

CONTACT SIZE	AXIAL LOAD		SEPARATION FORCE MINIMUM	
	NEWTONS	LBS.	NEWTONS	LBS.
16	44	10	1	0.25
12	67	15	2	0.50
8	89	20	3	0.75
4	89	20	4	1.00
0	111	25	9	2.00

Polarization	Integral key and keyway plus optional rotational polarization ⇒ See pages 83-93 or valid rotations.
Approvals	MIL-DTL-5015

CREATE YOUR PART NUMBER USING THESE EIGHT STEPS

STEP	1	2	3	4	5	6	7	8
	6	A	A	24-21	S		S	-472
SERIES PREFIX	SHELL STYLE	ENDBELLS (If omitting endbell, enter -)	CABLE CLAMP/BOOT (leave blank if not needed)	LAYOUT	CONTACT	ROTATION	CONTACT TYPE	PLATING

(example)

STEP 1: SELECT SHELL STYLE, PLUG OR RECEPTACLE

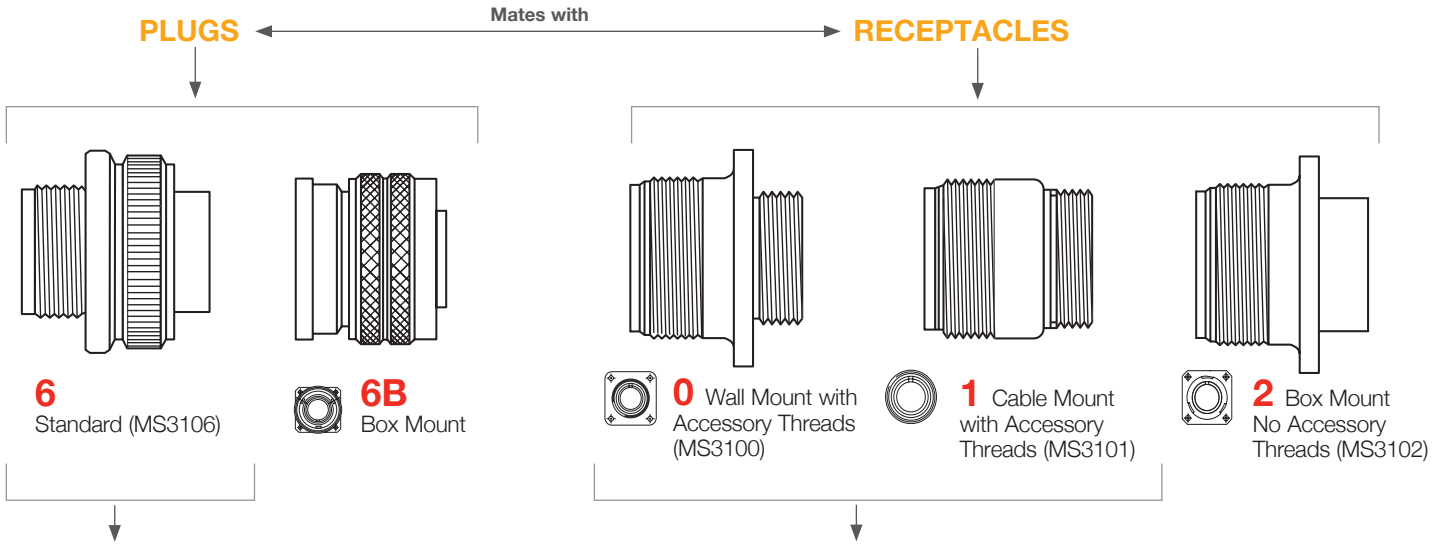

STEP 2: SELECT ENDBELL

TIP: Order connector, backshell and all accessories as one part number! See www.peigenesis.com/en/solution-guides.html

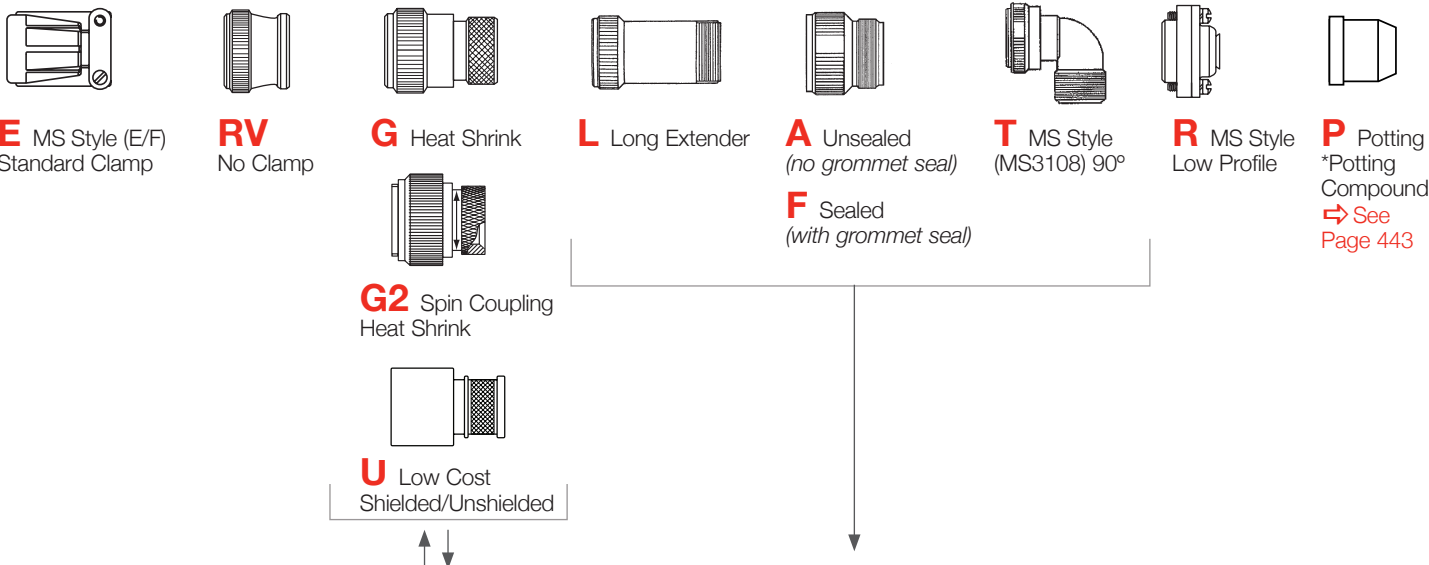

STEP 3: SELECT CABLE CLAMP OR BOOT (IF APPLICABLE)

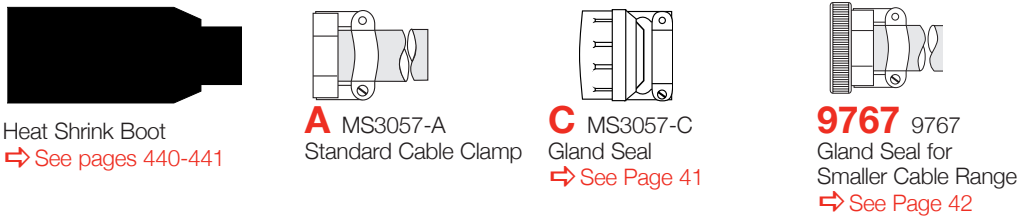

STEP 4: SELECT LAYOUT

⇒ See pages 72-82

STEP 5: SELECT CONTACT

P = Pin S = Socket

STEP 6: SELECT ROTATION

⇒ See pages 83-93 (Omit for normal)

W, X, Y, Z

STEP 7: SELECT CONTACT TYPE

S = Solder C = Crimp*
H = PC** O = Less Contacts

* When using a "C" in part number, the connector is supplied with the standard size crimp contacts for its layout. Bolded part numbers on ⇒ page 30 indicate crimp contact. Please contact us for connectors with reduced or enlarged crimp barrel contacts.
** ⇒ See page 38 for post diameters and lengths.

STEP 8: SELECT PLATING

CONTACTS

(Omit for silver contacts)

- B30** = Gold 50µ Gold over Nickel
- T** = Thermocouple (*solder only*)
Need types with cavities and installed and uninstalled
- RDS** = RADSOK (Crimp socket only)
sizes 12,8,4,0
- 116** = Less pre-tinned solder cups

SHELL PLATING

(Omit for olive drab chromate over cadmium (MS style))

- 023** = Electroless Nickel
(*RoHS with crimp or 116 contacts*)
- 024** = Green Zinc Cobalt
- 025** = Black Alloy
(*RoHS with crimp or 116 contacts*)
- 027** = Conductive Black Alloy
(*RoHS with crimp or 116 contacts*)
- G96** = Black Anodized
- 472** = 116&025 mod codes (*RoHS*)
- 548** = 116&023 mod codes (*RoHS*)
- 553** = 116&027 mod codes (*RoHS*)

MATERIALS

(Omit for standard neoprene)

- L** = Low-smoke, zero-halogen
- V** = High-temperature Viton®

STANDARD SPECIALS — CONTACT US WITH NPT THREAD SIZE, SEAL TITE CONDUIT DIAMETER, OR CABLE OUTSIDE DIAMETER.

INTERNAL THREAD VERSION

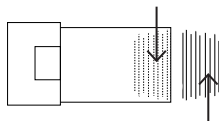

EXTERNAL THREAD VERSION

LOW COST GLAND SEAL

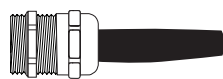

CONDUIT PLASTIC

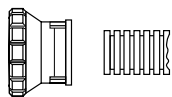

⇒ See pages 445

CONDUIT METAL

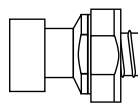

GLAND SEAL

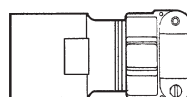

SHIELDED CABLE

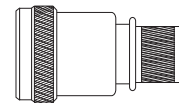

MESH GRIP

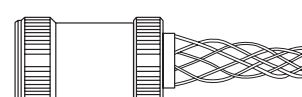

NEED HELP? PEI engineers will help you solve your design challenges and build the perfect part for your application. Email us at sales@peigenesis.com or complete our online Technical Request at www.peigenesis.com/technical-support. To contact us by phone, please see the back cover for a complete listing of our branch offices and contact numbers.

PIN & SOCKET CRIMP CONTACTS



CONTACT SIZE	WIRE SIZE AWG	PART NUMBER				WIRE STRIP LENGTHS INCHES (MM)	WIRE SEALING RANGE INCHES (MM)			
		PIN CONTACT		SOCKET CONTACT						
		SILVER	GOLD	SILVER	GOLD					
16S[†]	16-18-20	AIC16S-16P*	AIC16S-16PG*	AIC16S-16S*	AIC16S-16SG*	0.312 (7.9)	.090-.118 (2.3-3.0)			
	12-14	AIC16S-12P	AIC16S-12PG	AIC16S-12S	AIC16S-12SG			C4		
	14-16	AIC16S-14P	AIC16S-14PG	AIC16S-14S	AIC16S-14SG			C3		
	18-20	AIC16S-20P	AIC16S-20PG	AIC16S-20S	AIC16S-20SG			C13		
	20-22	AIC16S-22P	AIC16S-22PG	AIC16S-22S	AIC16S-22SG			C14		
	22-24	AIC16S-24P	AIC16S-24PG	AIC16S-24S	AIC16S-24SG			C2		
16	16-18-20	AIC16-16P*	AIC16-16PG*	AIC16-16S*	AIC16-16SG*			0.312 (7.9)	.090-.118 (2.3-3.0)	
	12-14	AIC16-12P	AIC16-12PG	AIC16-12S	AIC16-12SG					C4
	14-16	AIC16-14P	AIC16-14PG	AIC16-14S	AIC16-14SG					C3
	18-20	AIC16-18P	AIC16-18PG	AIC16-18S	AIC16-18SG					C13
	20-22	AIC16-20P	AIC16-20PG	AIC16-20S	AIC16-20SG					C14
	20-24	AIC16-2024P	AIC16-2024PG	AIC16-2024S	AIC16-2024SG					C36
	22-24	AIC16-22P	AIC16-22PG	AIC16-22S	AIC16-22SG	C2				
12	12-14	AIC12-12P*	AIC12-12PG*	AIC12-12S*	AIC12-12SG*	0.312 (7.9)	.126-.177 (3.2-4.5)			
	12 High-Power	-	-	AIC12-12SRAD	-					
	8-10	AIC12-8P	AIC12-8PG	AIC12-8S	AIC12-8SG					C5
	10-12	AIC12-10P	AIC12-10PG	AIC12-10S	AIC12-10SG					C8
	14-16	AIC12-14P	AIC12-14PG	AIC12-14S	AIC12-14SG					C9
	16-18	AIC12-16P	AIC12-16PG	AIC12-16S	AIC12-16SG			C7		
	18-20	AIC12-18P	AIC12-18PG	AIC12-18S	AIC12-18SG			C6		
	20-22	AIC12-20P	AIC12-20PG	AIC12-20S	AIC12-20SG			C40		
8	8	AIC8-8P*	AIC8-8PG*	AIC8-8S*	AIC8-8SG*	0.563 (14.3)	.150-.256 (3.8-6.5)			
	8 High-Power	-	-	AIC8-8SRAD	-					
	10-12	AIC8-10P	AIC8-10PG	AIC8-10S	AIC8-10SG			C10		
	12-14	AIC8-12P	AIC8-12PG	AIC8-12S	AIC8-12SG			C38		
4	4	AIC4-4P*	AIC4-4PG*	AIC4-4S*	AIC4-4SG*	0.500 (12.7)	.279-.366 (7.1-9.3)			
	4 High-Power	-	-	AIC4-4SRAD	-					
	8	AIC4-8P	AIC4-8PG	AIC4-8S	AIC4-8SG			C15		
0	0	AIC0-0P*	AIC0-0PG*	AIC0-0S*	AIC0-0SG*	0.750 (19.0)	.394-.539 (10.0-13.7)			
	0 High-Power	-	-	AIC0-0SRAD	-					
	0-2	AIC0-2P	AIC0-2PG	AIC0-2S	AIC0-2SG			C11		
	4	AIC0-4P	AIC0-4PG	AIC0-4S	AIC0-4SG			C12		

*Bolded items are standard crimp contacts.



SOLDER THERMOCOUPLE CONTACTS			
	TYPE	PINS	SOCKETS
16S[†]	Alumel	10-040799-02P*	10-040799-02S*
	Chromel	10-040799-01P*	10-040799-01S*
	Iron	10-040799-03P*	10-040799-03S*
	Constantan	10-040799-04P*	10-040799-04S*
16	Alumel	10-040799-12P*	10-040799-12S*
	Chromel	10-040799-11P*	10-040799-11S*
	Iron	10-040799-13P*	10-040799-13S*
	Constantan	10-040799-14P*	10-040799-14S*

SOLDER THERMOCOUPLE CONTACTS			
	TYPE	PINS	SOCKETS
12	Alumel	10-040799-42P*	10-040799-42S*
	Chromel	10-040799-41P*	10-040799-41S*
	Iron	10-040799-43P*	10-040799-43S*
	Constantan	10-040799-44P*	10-040799-44S*

Thermocouple Types: **J** = Iron-Constantan **K** = Alumel-Chromel
T = Copper-Constantan **E** = Chromel-Constantan

*Contact us for availability. Contact information is below.

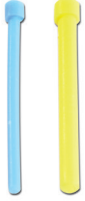

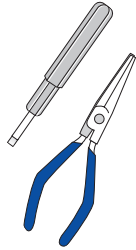
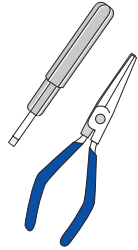

† 16S contacts are used in 8S, 10S, 10SL, 12S, 14S & 16S connector sizes only.

ACCESSORIES		TOOLS						
 Insert head first. Trim excess		 AF8 WA27F TH29-1 400BHD Die set, locator and Go-No-Go gauge						
CONTACT SIZE	WIRE HOLE FILLER COLOR	CRIMP TOOLS	CRIMP LOCATOR & DIE SETS	LOCATOR COLOR	PILOT PIN/INSERTION GUIDE FOR SOCKETS	INSERTION TOOL	EXTRACTION TOOL	
16S†	Blue MS27488-16-3	AF8-(hand) WA27F-(pneumatic) ††	TH29-1	Red	10-242758-016	DAK168-16	DRK59 Kit with Multiple Tips	
16				Pin-Blue Socket- Green				
12	Yellow MS27488-12-3			Green	10-242758-012	DAK168-12		
8	Red MS27488-8-3	400BHD	Die Set 414DA-8N Locator 4025-Pin 4026-Socket	-	10-242758-008	DAK282		
4	Blue MS27488-4-3		Die Set 414DA-4N Locator 4043-2	-	-	AIC4INS	AIC4EXT	
0	Yellow MS27488-0-3		Die Set 414DA-0N Locator 4042	-	-	AIC0INS	AIC0EXT	

†† Contact us for additional tool accessories. Contact information is below.

All dimensions in inches (millimeters in parenthesis)

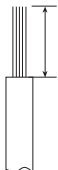
PIN & SOCKET COAX CONTACTS

		PIN CONTACT		SOCKET CONTACT		WIRE STRIP LENGTH	WIRE RANGE		ACCESSORIES
									 Insert head first. Trim excess.
COAX CONTACT SIZE	COAX WIRE SIZE	PART NUMBER				WIRE STRIP LENGTHS INCHES (mm)	WIRE SEALING RANGE INCHES (mm)		WIRE HOLE FILLER
		PINS		SOCKETS			MIN.	MAX.	
		SILVER	GOLD	SILVER	GOLD				
12	RG161/U RG174A/U RG179B/U RG187A/U RG188A/U RG316/U	21-33034-1	21-33014-21 21-33048-1(0) 21-33130-1(0)	21-33033-1	21-33013-21 21-33047-1(0) 21-33129-1(0)	Contact us for details.	0.126 (3.2 mm)	0.177 (4.5 mm)	Yellow 10-405996-12
	RG178B/U RG196A/U	-	21-33014-22	-	21-33013-22				
8	RG58C/U RG141A/U RG303/U	21-33034-2(1)	21-33014-1(5) 21-33016-5(3) 21-33130-2(0)	21-33033-2(1) 21-33048-2(0)	21-33013-1(5) 21-33047-2(0) 21-33015-5(3) 21-33129-2(0)	Contact us for details.	0.150 (3.8 mm)	0.256 (6.5 mm)	White 10-405996-8
	RG59B/U RG62A/U RG62B/U RG210/U	21-33034-5(1)	21-33014-5(5) 21-33016-2(3) 21-33130-5(0) 21-33064-21(0)	21-33033-3(1)	21-33013-5(5) 21-33015-2(3) 21-33129-3(0) 21-33063-21(0)				
	RG161/U RG174A/U RG179B/U RG187A/U RG188A/U RG316/U	21-33034-3(1)	21-33014-3(5) 21-33016-1(3) 21-33130-3(0) 21-33064-20(0)	21-33033-3(1)	21-33013-3(5) 21-33015-1(3) 21-33129-3(0) 21-33063-20(0)				
	RG180B/U RG195A/U	21-33034-6	21-33014-6(5) 21-33048-3(0) 21-33130-6(0)	21-33033-6	21-33013-(6) 21-33047-3(0) 21-33129-6(0)				
	RG140/U RG302/U	21-33034-8	21-33014-8(5) 21-33033-8 21-33130-8(0)	-	21-33013-8(5) 21-33129-8(0)				
	RG55B/U RG142A/U RG142B/U RG223/U	21-33034-4	21-33014-5(5) 21-33130-4(0)	21-33033-4	21-33013-5(5) 21-33129-4(0)				
4	RG59B/U RG62A/U RG62B/U RG210/U		21-33060-10(0)		21-33059-10(0)	Contact us for details.	0.279 (7.1 mm)	0.366 (9.3 mm)	Blue 10-405996-4
	RG212/U	-	21-33060-11(0)	-	21-33059-11(0)				
	RG55B/U RG142A/U RG142B/U RG223/U		31-33060-12(0)		21-33059-12(0)				

() Various platings available. Availability of coax contacts varies widely. Contact us for details. Contact information is below. All dimensions in inches (millimeters in parenthesis)

TOOLS



Crimp Dies

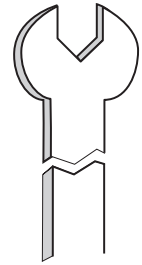

COAX CONTACT SIZE	COAX WIRE SIZE	HAND CRIMP TOOL	CRIMP DIES	USE LOCATOR	COAX CLAMP NUT WRENCH
12	RG161/U RG174A/U RG179B/U RG187A/U RG188A/U RG316/U	M22520/10-01	M22520/10-05	A	11-8676-1
	RG178B/U RG196A/U			B	
8	RG58C/U RG141A/U RG303/U	M22520/10-01	M22520/10-07	B	11-8676-2
	RG59B/U RG62A/U RG62B/U RG210/U	M22520/5-01	M22520/5-45	B	11-8676-3
	RG161/U RG174A/U RG179B/U RG187A/U RG188A/U RG316/U	M22520/10-01	M22520/10-05	A	11-8676-2
	RG180B/U RG195A/U		B		
RG140/U RG302/U	M22520/10-07		A		
RG55B/U RG142A/U RG142B/U RG223/U	A				
4	RG59B/U RG62A/U RG62B/U RG210/U	M22520/5-01	M22520/5-45	B	-
	RG212/U	M22520/5-01	M22520/5-34	A	11-8676-4
	RG55B/U RG142A/U RG142B/U RG223/U	M22520/10-01	M22520/10-07	A	-

All dimensions in inches (millimeters in parenthesis)

RECEPTACLE STYLES

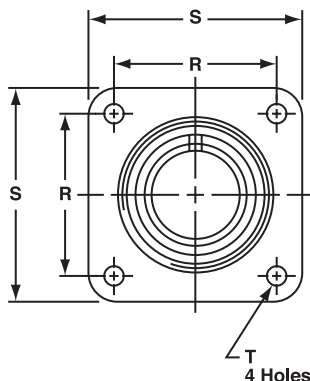

AIT0-MS3100
AIT2-MS3102

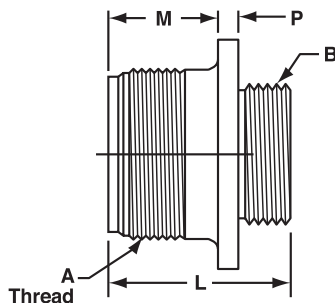

AIT0-MS3100

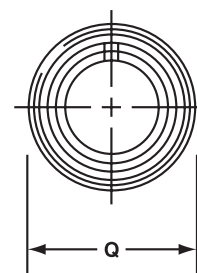

AIT1-MS3101

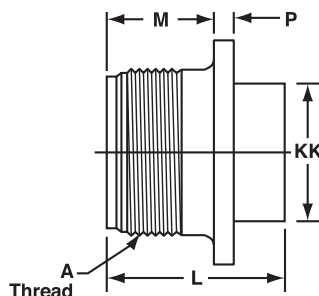

AIT2-MS3102

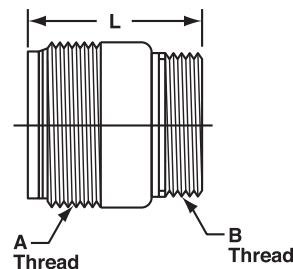

AIT1-MS3101

SHELL SIZE	A THREAD CLASS 2A	AIT0-MS3100/AIT2-MS3102					AIT2-MS3102		AIT0/AIT1	AIT1	AIT0/AIT1 B THREAD CLASS 2A
		M +.010 -.000	P REF.	R +/- .005	S +/- .031	T DIA. +.004 -.002	L REF LENGTH	KK DIA. +.010 -.000	LENGTH 3100 3101	Q DIA.	
8S	.5000-28UNEF	0.562 (14.3)	0.110 (2.8)	0.594 (15.1)	0.875 (22.2)	0.120 (3.0)	0.969 (24.6)	0.375 (9.5)	1.087 (27.6)	0.532 (13.5)	.5000-28UNEF
10S	.6250-24NEF	0.562 (14.3)	0.110 (2.8)	0.719 (18.3)	1.000 (25.4)	0.120 (3.0)	0.969 (24.6)	0.500 (12.7)	1.087 (27.6)	0.628 (16.0)	.5000-28UNEF
10SL	.6250-24NEF	0.562 (14.3)	0.110 (2.8)	0.719 (18.3)	1.000 (25.4)	0.120 (3.0)	0.969 (24.6)	0.625 (15.9)	1.087 (27.6)	0.755 (19.2)	.6250-24UNEF
12S	.7500-20UNEF	0.562 (14.3)	0.110 (2.8)	0.812 (20.6)	1.094 (27.8)	0.120 (3.0)	0.969 (24.6)	0.625 (15.9)	1.087 (27.6)	0.755 (19.2)	.6250-24UNEF
12	.7500-20UNEF	0.750 (19.1)	0.110 (2.8)	0.812 (20.6)	1.094 (27.8)	0.120 (3.0)	1.344 (34.1)	0.625 (15.9)	1.334 (33.9)	0.755 (19.2)	.6250-24UNEF
14S	.8750-20UNEF	0.562 (14.3)	0.110 (2.8)	0.906 (23.0)	1.188 (30.2)	0.120 (3.0)	0.969 (24.6)	0.750 (19.1)	1.087 (27.6)	0.882 (22.4)	.7500-20UNEF
14	.8750-20UNEF	0.750 (19.1)	0.110 (2.8)	0.906 (23.0)	1.188 (30.2)	0.120 (3.0)	1.344 (34.1)	0.750 (19.1)	1.334 (33.9)	0.882 (22.4)	.7500-20UNEF
16S	1.0000-20UNEF	0.562 (14.3)	0.110 (2.8)	0.969 (24.6)	1.281 (32.5)	0.120 (3.0)	0.969 (24.6)	0.875 (22.2)	1.087 (27.6)	1.010 (25.7)	.8750-20UNEF
16	1.0000-20UNEF	0.750 (19.1)	0.110 (2.8)	0.969 (24.6)	1.281 (32.5)	0.120 (3.0)	1.344 (34.1)	0.875 (22.2)	1.334 (33.9)	1.010 (25.7)	.8750-20UNEF
18	1.1250-18NEF	0.750 (19.1)	0.141 (3.6)	1.062 (27.0)	1.375 (34.9)	0.120 (3.0)	1.344 (34.1)	1.000 (25.4)	1.334 (33.9)	1.137 (28.9)	1.0000-20UNEF
20	1.2500-18NEF	0.750 (19.1)	0.141 (3.6)	1.156 (29.4)	1.500 (38.1)	0.120 (3.0)	1.344 (34.1)	1.125 (28.6)	1.334 (33.9)	1.264 (32.1)	1.1250-18UNEF
22	1.3750-18NEF	0.750 (19.1)	0.141 (3.6)	1.250 (31.8)	1.625 (41.3)	0.120 (3.0)	1.344 (34.1)	1.250 (31.8)	1.334 (33.9)	1.392 (35.4)	1.2500-18UNEF
24	1.5000-18NEF	0.812 (20.6)	0.141 (3.6)	1.375 (34.9)	1.750 (44.5)	0.147 (3.7)	1.406 (35.7)	1.375 (34.9)	1.406 (35.7)	1.519 (38.6)	1.3750-18UNEF
28	1.7500-18NS	0.812 (20.6)	0.141 (3.6)	1.562 (39.7)	2.000 (50.8)	0.147 (3.7)	1.406 (35.7)	1.625 (41.3)	1.406 (35.7)	1.774 (45.1)	1.6250-18UNEF
32	2.0000-18NS	0.875 (22.2)	0.156 (4.0)	1.750 (44.5)	2.250 (57.2)	0.173 (4.4)	1.469 (37.3)	1.875 (47.6)	1.469 (37.3)	1.996 (50.7)	1.8750-16UN
36	2.2500-16UN	0.875 (22.2)	0.156 (4.0)	1.938 (49.2)	2.500 (63.5)	0.173 (4.4)	1.469 (37.3)	2.062 (52.4)	1.469 (37.3)	2.251 (57.2)	2.0625-16UN
40	2.5000-16UN	0.875 (22.2)	0.156 (4.0)	2.188 (55.6)	2.750 (69.9)	0.173 (4.4)	1.469 (37.3)	2.312 (58.7)	1.469 (37.3)	2.506 (63.7)	2.3125-16UN

All dimensions in inches (millimeters in parenthesis)

ENDBELL STYLES

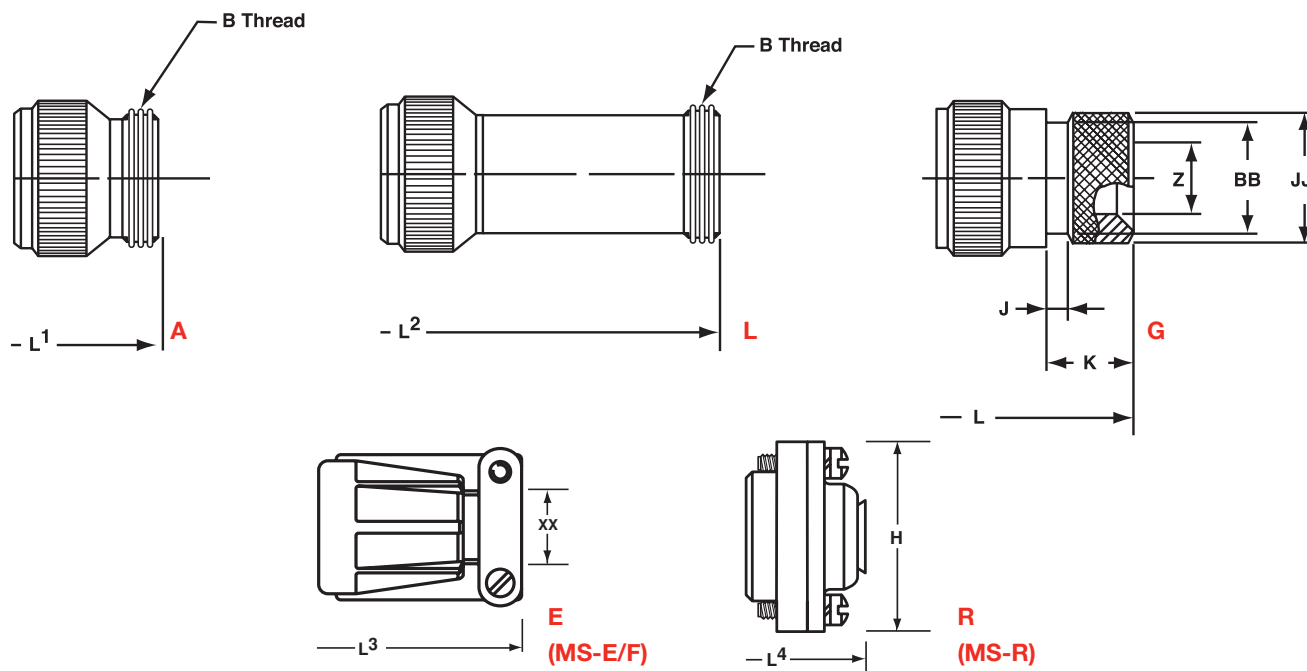

SHELL SIZE	AIT0-MS3100/AIT1-MS3101							AIT0/AIT1 G					
	A & L ENDBELL			E ENDBELL		R ENDBELL		L MAX.	J ± .008 (±0.2)	K ± .020 (+0.5)	Z MIN.	BB MAX.	JJ ±.008 (+.02)
	L ¹	L ² MAX.	B THREAD CLASS 2A	L	XX CABLE MIN.	L	H DIA MAX.						
8S	1.390 (35.3)	3.20 (81.20)	.5000-28UNEF	-	-	1.588 (40.3)	0.959 (24.4)	-	-	-	-	-	-
10S	1.468 (37.3)	3.20 (81.20)	.5000-28UNEF	-	-	1.588 (40.3)	1.026 (26.1)	-	-	-	-	-	-
10SL	1.468 (37.3)	3.23 (93.6)	.6250-24NEF	2.129 (54.1)	0.281 (7.1)	1.588 (40.3)	1.120 (28.4)	1.969 (50.0)	0.138 (3.5)	0.461 (11.7)	0.303 (7.7)	0.524 (13.3)	0.610 (15.5)
12S	1.468 (37.3)	3.58	.6250-24NEF	2.129 (54.1)	0.281 (7.1)	1.588 (40.3)	1.120 (28.4)	-	-	-	-	-	-
12	1.843 (46.8)	3.66	.6250-24NEF	2.129 (54.1)	0.281 (7.1)	1.931 (49.0)	1.120 (28.4)	-	-	-	-	-	-
14S	1.468 (37.3)	3.23 (82.09)	.7500-20UNEF	2.201 (55.9)	0.406 (10.3)	1.588 (40.3)	1.307 (33.2)	1.969 (50.0)	0.138 (3.5)	0.461 (11.7)	0.417 (10.6)	0.669 (17.0)	0.752 (19.1)
14	1.843 (46.8)	3.64	.7500-20UNEF	2.524 (62.1)	0.406 (10.3)	1.931 (49.0)	1.307 (33.2)	-	-	-	-	-	-
16S	1.468 (37.3)	3.23 (82.09)	.8750-20UNEF	2.201 (55.9)	0.500 (12.7)	1.588 (40.3)	1.432 (36.4)	1.969 (50.0)	0.138 (3.5)	0.461 (11.7)	0.531 (13.5)	0.862 (21.9)	0.941 (23.9)
16	1.843 (46.8)	3.58 (91.03)	.8750-20UNEF	2.524 (62.1)	0.500 (12.7)	1.931 (49.0)	1.432 (36.4)	2.362 (60.0)	0.138 (3.5)	0.453 (11.5)	0.531 (13.5)	0.862 (21.9)	0.941 (23.9)
18	1.938 (49.2)	3.66 (92.94)	1.000-20UNEF	2.596 (65.9)	0.531 (13.5)	1.931 (49.0)	1.557 (39.5)	2.362 (60.0)	0.138 (3.5)	0.453 (11.5)	0.575 (14.5)	0.862 (21.9)	0.941 (23.9)
20	1.844 (46.8)	3.64 (92.56)	1.1875-18NEF	2.654 (67.4)	0.656 (16.7)	1.931 (49.0)	1.744 (44.3)	2.559 (65.0)	0.138 (3.5)	0.500 (12.7)	0.736 (18.7)	1.031 (26.2)	1.165 (29.6)
22	1.938 (49.2)	3.65 (92.68)	1.1875-18NEF	2.654 (67.4)	0.740 (18.8)	1.931 (49.0)	1.869 (47.5)	2.559 (65.0)	0.138 (3.5)	0.500 (12.7)	0.819 (20.8)	1.031 (26.2)	1.165 (29.6)
24	1.969 (50.0)	3.73 (94.64)	1.4375-18NEF	2.885 (73.3)	0.781 (19.8)	2.009 (51.0)	1.994 (50.6)	2.559 (65.0)	0.138 (3.5)	0.500 (12.7)	0.969 (24.6)	1.358 (34.5)	1.488 (37.8)
28	2.188 (55.6)	3.90 (98.96)	1.4375-18NEF	2.885 (73.3)	0.922 (23.4)	2.009 (51.0)	2.166 (55.0)	2.559 (65.0)	0.138 (3.5)	0.500 (12.7)	1.063 (27.0)	1.358 (34.5)	1.488 (37.8)
32	2.157 (54.8)	4.10 (104.24)	1.7500-18NS	2.943 (74.8)	1.156 (29.4)	2.072 (52.6)	2.541 (64.5)	2.756 (70.0)	0.138 (3.5)	0.598 (15.2)	1.311 (33.3)	1.717 (43.6)	1.882 (47.8)
36	2.219 (56.4)	4.15 (105.38)	2.0000-18NS	2.943 (74.8)	1.250 (31.8)	2.072 (52.6)	2.729 (69.3)	3.150 (80.0)	0.138 (3.5)	0.598 (15.2)	1.516 (38.5)	1.717 (43.6)	1.882 (47.8)
40	2.188 (55.6)	4.15 (105.38)	2.2500-16UN	3.068 (77.9)	1.562 (39.7)	2.072 (52.6)	2.979 (75.7)	3.150 (80.0)	0.138 (3.5)	0.610 (15.5)	1.898 (48.2)	2.070 (52.6)	2.276 (57.8)

All dimensions in inches (millimeters in parenthesis)

DIMENSIONS

STYLE 6 PLUGS (BARREL ASSEMBLY)

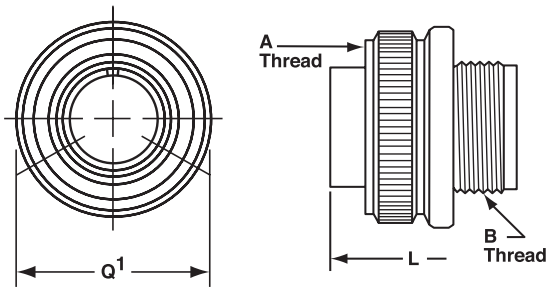

AIT6-MS3106
MS3108

STYLE 6 ENDBELLS

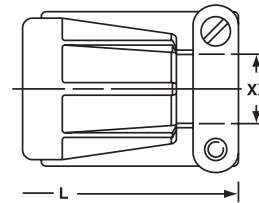
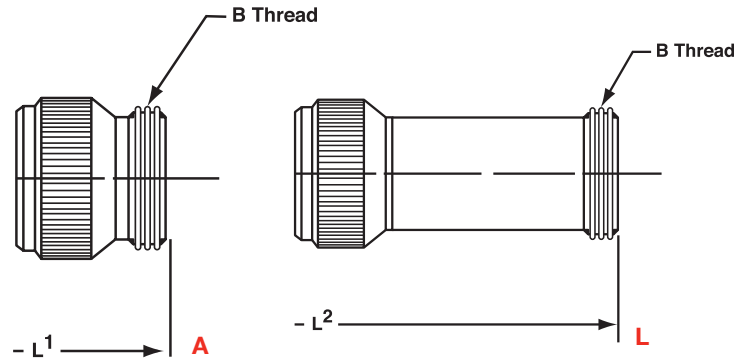

E
MS3106E
MS3106F

SHELL SIZE	A THREAD CLASS 2B	Q1 DIA. MAX.	BARREL B THREAD CLASS 2A
8S	.5000-28UNEF	0.741 (18.8)	.5000-28UNEF
10S	.6250-24NEF	0.869 (22.1)	.5000-28UNEF
10SL	.6250-24NEF	0.946 (24.0)	.6250-24UNEF
12S	.7500-20UNEF	0.995 (25.3)	.6250-24UNEF
12	.7500-20UNEF	0.995 (25.3)	.6250-24UNEF
14S	.8750-20UNEF	1.123 (28.5)	.7500-20UNEF
14	.8750-20UNEF	1.123 (28.5)	.7500-20UNEF
16S	1.0000-20UNEF	1.250 (31.8)	.8750-20UNEF
16	1.0000-20UNEF	1.250 (31.8)	.8750-20UNEF
18	1.1250-18NEF	1.333 (33.9)	1.0000-20UNEF
20	1.2500-18NEF	1.461 (37.1)	1.1250-18UNEF
22	1.3750-18NEF	1.588 (40.3)	1.2500-18UNEF
24	1.5000-18NEF	1.715 (43.6)	1.3750-18UNEF
28	1.7500-18NS	1.968 (50.0)	1.6250-18UNEF
32	2.0000-18NS	2.209 (56.1)	1.8750-16UN
36	2.2500-16UN	2.463 (62.6)	2.0625-16UN
40	2.5000-16UN	2.719 (69.1)	2.3125-16UN

A & L		
L ¹	L ²	B THREAD CLASS 2A
1.390 (35.3)	-	.5000-28UNEF
1.468 (37.3)	-	.5000-28UNEF
1.468 (37.3)	3.684 (93.6)	.6250-24NEF
1.468 (37.3)	-	.6250-24NEF
1.843 (46.8)	-	.6250-24NEF
1.468 (37.3)	3.748 (95.2)	.7500-20UNEF
1.843 (46.8)	-	.7500-20UNEF
1.468 (37.3)	3.748 (95.2)	.8750-20UNEF
1.843 (46.8)	3.710 (94.2)	.8750-20UNEF
1.938 (49.2)	4.094 (104.0)	1.0000-20UNEF
1.844 (46.8)	4.094 (104.0)	1.1875-18NEF
1.938 (49.2)	4.102 (104.2)	1.1875-18NEF
1.970 (50.0)	3.950 (100.4)	1.4375-18NEF
2.189 (55.6)	4.392 (111.6)	1.4375-18NEF
2.158 (54.8)	5.038 (128.0)	1.7500-18NS
2.219 (56.4)	4.354 (100.6)	2.0000-18NS
2.188 (55.6)	4.354 (110.6)	2.2500-16UN

MS3106E/MS3106F	
L MAX.	CABLE MIN. XX
---	---
---	---
---	---
2.129 (54.1)	0.281 (7.1)
2.129 (54.1)	0.281 (7.1)
2.129 (54.1)	0.281 (7.1)
2.201 (55.9)	0.406 (10.3)
2.524 (64.1)	0.406 (10.3)
2.201 (55.9)	0.500 (12.7)
2.524 (64.1)	0.500 (12.7)
2.596 (65.9)	0.531 (13.5)
2.654 (67.4)	0.656 (16.7)
2.654 (67.4)	0.740 (18.8)
2.885 (73.3)	0.781 (19.8)
2.885 (73.3)	0.922 (23.4)
2.943 (74.8)	1.156 (29.4)
2.943 (74.8)	1.250 (31.8)
3.068 (77.9)	1.562 (39.7)

All dimensions in inches (millimeters in parenthesis)

STYLE 6 RIGHT ANGLE ENDBELLS

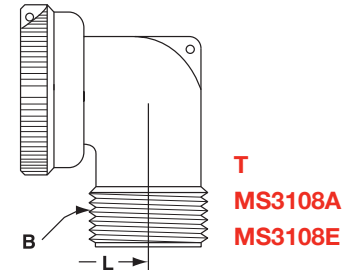
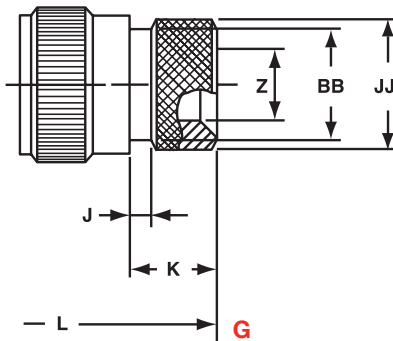
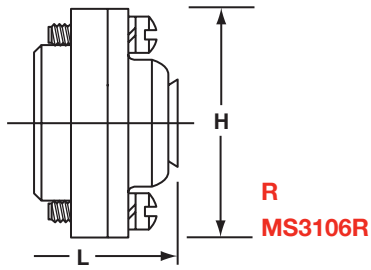

SHELL SIZE	R		G						3108	
	L MAX.	H DIA. MAX.	L MAX.	J ± .008 (±0.2)	K +.020 (+0.5)	Z MIN.	BB MAX.	JJ +.008 (+0.2)	L MAX.	B THREAD CLASS 2A
8S	1.588 (40.3)	0.959 (24.4)	-	-	-	-	-	-	1.427 (36.2)	.5000-28UNEF
10S	1.588 (40.3)	1.026 (26.1)	-	-	-	-	-	-	1.458 (37.0)	.5000-28UNEF
10SL	1.588 (40.3)	1.120 (28.4)	1.969 (50.0)	0.138 (3.5)	0.461 (11.7)	0.303 (7.7)	0.524 (13.3)	0.610 (15.5)	1.482 (37.6)	.6250-24NEF
12S	1.588 (40.3)	1.120 (28.4)	-	-	-	-	-	-	1.487 (37.8)	.6250-24NEF
12	1.931 (49.0)	1.120 (28.4)	-	-	-	-	-	-	1.862 (47.3)	.6250-24NEF
14S	1.588 (40.3)	1.307 (33.2)	1.969 (50.0)	0.138 (3.5)	0.461 (11.7)	0.417 (10.6)	0.669 (17.0)	0.752 (19.1)	1.651 (41.9)	.7500-20UNEF
14	1.931 (49.0)	1.307 (33.2)	-	-	-	-	-	-	1.926 (48.9)	.7500-20UNEF
16S	1.588 (40.3)	1.432 (36.4)	1.969 (50.0)	0.138 (3.5)	0.461 (11.7)	0.531 (13.5)	0.862 (21.9)	0.941 (23.9)	1.677 (42.6)	.8750-20UNEF
16	1.931 (49.0)	1.432 (36.4)	2.362 (60.0)	0.138 (3.5)	0.453 (11.5)	0.531 (13.5)	0.862 (21.9)	0.941 (23.9)	2.051 (52.1)	.8750-20UNEF
18	1.931 (49.0)	1.557 (39.5)	2.362 (60.0)	0.138 (3.5)	0.453 (11.5)	0.575 (14.5)	0.862 (21.9)	0.941 (23.9)	2.114 (53.7)	1.0000-20UNEF
20	1.931 (49.0)	1.744 (44.3)	2.559 (65.0)	0.138 (3.5)	0.500 (12.7)	0.736 (18.7)	1.031 (26.2)	1.165 (29.6)	2.364 (60.0)	1.1875-18NEF
22	1.931 (49.0)	1.869 (47.5)	2.559 (65.0)	0.138 (3.5)	0.500 (12.7)	0.819 (20.8)	1.031 (26.2)	1.165 (29.6)	2.364 (60.0)	1.1875-18NEF
24	2.009 (51.0)	1.994 (50.6)	2.559 (65.0)	0.138 (3.5)	0.500 (12.7)	0.969 (24.6)	1.358 (34.5)	1.488 (37.8)	2.615 (66.4)	1.4375-18NEF
28	2.009 (51.0)	2.166 (55.0)	2.559 (65.0)	0.138 (3.5)	0.500 (12.7)	1.063 (27.0)	1.358 (34.5)	1.488 (37.8)	2.615 (66.4)	1.4375-18NEF
32	2.072 (52.6)	2.541 (64.5)	2.756 (70.0)	0.138 (3.5)	0.598 (15.2)	1.311 (33.3)	1.717 (43.6)	1.882 (47.8)	2.837 (72.1)	1.7500-18NS
36	2.072 (52.6)	2.729 (69.3)	3.150 (80.0)	0.138 (3.5)	0.598 (15.2)	1.516 (38.5)	1.717 (43.6)	1.882 (47.8)	2.895 (73.5)	2.0000-18NS
40	2.072 (52.6)	2.979 (75.7)	3.150 (80.0)	0.138 (3.5)	0.610 (15.5)	1.898 (48.2)	2.070 (52.6)	2.276 (57.8)	3.020 (76.7)	2.2500-16UN

All dimensions in inches (millimeters in parenthesis)

PRINTED CIRCUIT CONTACTS

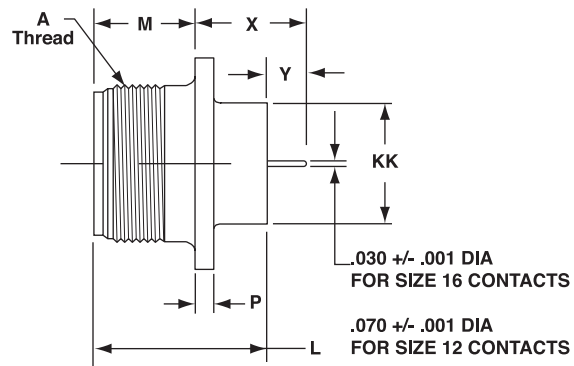
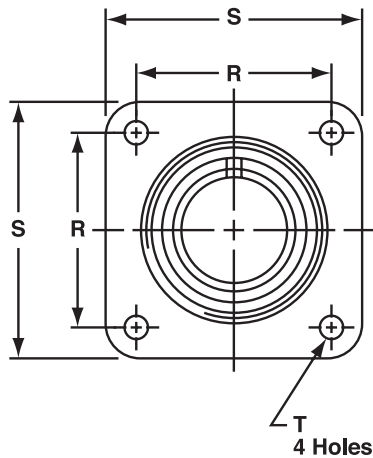

SHELL SIZE	USE AIT OR AMPHENOL PART NUMBER	A THREAD CLASS 2A	M +.010 -.000	P REF.	R (TP) +/- .005	S +/- .031	T DIA. +.004 -.002	3102 REF. L	KK DIA. +.010 -.000	X REF.	Y REF. +/- .045
8S	10-602460-XXX	.5000-28UNEF	0.562 (14.3)	0.110 (2.8)	0.594 (15.1)	0.875 (22.2)	0.120 (3.0)	0.969 (24.6)	0.375 (9.5)	0.595 (15.1)	0.188 (4.8)
10S	10-602461-XXX	.6250-24NEF	0.562 (14.3)	0.110 (2.8)	0.719 (18.3)	1.000 (25.4)	0.120 (3.0)	0.969 (24.6)	0.500 (12.7)	0.595 (15.1)	0.188 (4.8)
10SL	10-602462-XXX	.6250-24NEF	0.562 (14.3)	0.110 (2.8)	0.719 (18.3)	1.000 (25.4)	0.120 (3.0)	0.969 (24.6)	0.625 (15.9)	0.595 (15.1)	0.188 (4.8)
12S	10-602463-XXX	.7500-20UNEF	0.562 (14.3)	0.110 (2.8)	0.812 (20.6)	1.094 (27.8)	0.120 (3.0)	0.969 (24.6)	0.625 (15.9)	0.595 (15.1)	0.188 (4.8)
12	10-602464-XXX	.7500-20UNEF	0.750 (19.1)	0.110 (2.8)	0.812 (20.6)	1.094 (27.8)	0.120 (3.0)	1.344 (34.1)	0.625 (15.9)	0.782 (19.9)	0.188 (4.8)
14S	10-602465-XXX	.8750-20UNEF	0.562 (14.3)	0.110 (2.8)	0.906 (23.0)	1.188 (30.2)	0.120 (3.0)	0.969 (24.6)	0.750 (19.1)	0.595 (15.1)	0.188 (4.8)
14	10-602466-XXX	.8750-20UNEF	0.750 (19.1)	0.110 (2.8)	0.906 (23.0)	1.188 (30.2)	0.120 (3.0)	1.344 (34.1)	0.750 (19.1)	0.782 (19.9)	0.188 (4.8)
16S	10-602467-XXX	1.0000-20UNEF	0.562 (14.3)	0.110 (2.8)	0.969 (24.6)	1.281 (32.5)	0.120 (3.0)	0.969 (24.6)	0.875 (22.2)	0.595 (15.1)	0.188 (4.8)
16	10-602468-XXX	1.0000-20UNEF	0.750 (19.1)	0.110 (2.8)	0.969 (24.6)	1.281 (32.5)	0.120 (3.0)	1.344 (34.1)	0.875 (22.2)	0.782 (19.9)	0.188 (4.8)
18	10-602469-XXX	1.1250-18NEF	0.750 (19.1)	0.141 (3.6)	1.062 (27.0)	1.375 (34.9)	0.120 (3.0)	1.344 (34.1)	1.000 (25.4)	0.782 (19.9)	0.188 (4.8)
20	10-602470-XXX	1.2500-18NEF	0.750 (19.1)	0.141 (3.6)	1.156 (29.4)	1.500 (38.1)	0.120 (3.0)	1.344 (34.1)	1.125 (28.6)	0.782 (19.9)	0.188 (4.8)
22	10-602471-XXX	1.3750-18NEF	0.750 (19.1)	0.141 (3.6)	1.250 (31.8)	1.625 (41.3)	0.120 (3.0)	1.344 (34.1)	1.250 (31.8)	0.782 (19.9)	0.188 (4.8)
24	10-602472-XXX	1.5000-18NEF	0.812 (20.6)	0.141 (3.6)	1.375 (34.9)	1.750 (44.5)	0.147 (3.7)	1.406 (35.7)	1.375 (34.9)	0.782 (19.9)	0.188 (4.8)
28	10-602473-XXX	1.7500-18NS	0.812 (20.6)	0.141 (3.6)	1.562 (39.7)	2.000 (50.8)	0.147 (3.7)	1.406 (35.7)	1.625 (41.3)	0.782 (19.9)	0.188 (4.8)
32	10-602474-XXX	2.0000-18NS	0.875 (22.2)	0.156 (4.0)	1.750 (44.5)	2.250 (57.2)	0.173 (4.4)	1.469 (37.3)	1.875 (47.6)	0.782 (19.9)	0.188 (4.8)
36	10-602475-XXX	2.2500-16UN	0.875 (22.2)	0.156 (4.0)	1.938 (49.2)	2.500 (63.5)	0.173 (4.4)	1.469 (37.3)	2.062 (52.4)	0.782 (19.9)	0.188 (4.8)
40	10-602476-XXX	2.5000-16UN	0.875 (22.2)	0.156 (4.0)	2.188 (55.6)	2.750 (69.9)	0.173 (4.4)	1.469 (37.3)	2.312 (58.7)	0.782 (19.9)	0.188 (4.8)

XXX = Insert layout code. Contact us for correct code. Contact information is below.

All dimensions in inches (millimeters in parenthesis)

PANEL CUTOUTS

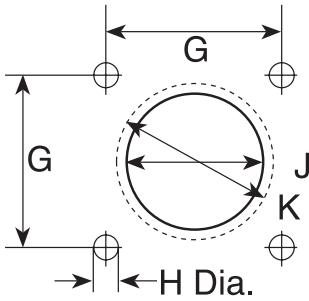

Dimension J is flange in front of panel. Dimension K is flange at rear of panel. See sealing screws on [page 439](#).

SHELL SIZE	FLANGE STYLE 0-2-6B			
	G	MOUNTING HOLE	FRONT MOUNT DIAMETER	REAR MOUNT
		H	J	K
8S	0.594 (15.1)	0.134 (3.4)	0.396 (10.1)	0.603 (15.4)
10S	0.717 (18.2)	0.134 (3.4)	0.525 (13.3)	0.728 (18.5)
10SL	0.717 (18.2)	0.134 (3.4)	0.646 (16.4)	0.728 (18.5)
12S/12	0.811 (20.6)	0.134 (3.4)	0.646 (16.4)	0.854 (21.7)
14S/14	0.906 (23.0)	0.134 (3.4)	0.776 (19.7)	0.980 (24.9)
16S/16	0.969 (24.6)	0.134 (3.4)	0.902 (22.9)	1.091 (27.7)
18	1.063 (27.0)	0.134 (3.4)	1.028 (26.1)	1.224 (31.1)
20	1.157 (29.4)	0.134 (3.4)	1.161 (29.5)	1.358 (34.5)
22	1.252 (31.8)	0.134 (3.4)	1.287 (32.7)	1.488 (37.8)
24	1.374 (34.9)	0.154 (3.9)	1.417 (36.0)	1.626 (41.3)
28	1.563 (39.7)	0.154 (3.9)	1.654 (42.0)	1.854 (47.1)
32	1.752 (44.5)	0.177 (4.5)	1.902 (48.3)	2.118 (53.8)
36	1.937 (49.2)	0.177 (4.5)	2.150 (54.6)	2.362 (60.0)
40	2.185 (55.5)	0.177 (4.5)	2.409 (61.2)	2.610 (66.3)

++ 6B panel plug is front mount only.

PANEL THICKNESS

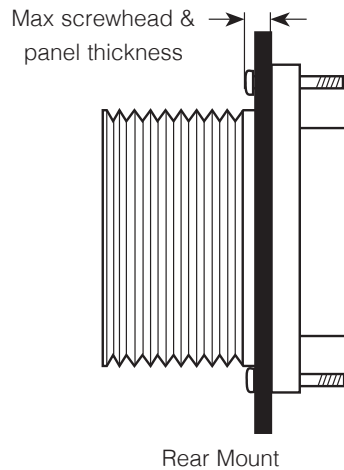
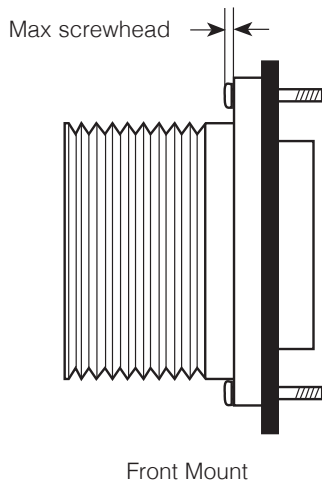

SHELL SIZE	FRONT MOUNT	REAR MOUNT
8SL	.125 (3.18)	.125 (3.18)
10S		.125 (3.18)
10SL		.125 (3.18)
12S/12SL		.125 (3.18)
12		.187 (4.75)
14S		.187 (4.75)
16S		.187 (4.75)
16		.187 (4.75)
18		.187 (4.75)
20		.187 (4.75)
22		.187 (4.75)
24		.187 (4.75)
28		.187 (4.75)
32		.250 (6.35)
36		.250 (6.35)
40		.250 (6.35)

All dimensions in inches (millimeters in parenthesis)

Pre-Earth Series/FMLB



FIRST-MATE, LAST-BREAK (FMLB) CONNECTOR THAT INTERMATES WITH MIL-DTL-5015

Amphenol's DL Pre-Earth /FMLB (first-mate, last-break) connectors are designed for applications where a protective circuit from the ground contact to the shell is a safety requirement. These connectors provide a path for stray voltage to be shunted to a safe ground to avoid damage to sensitive equipment or harm to operators.

- Intermateable with AIT, MIL-DTL-5015 & 97 series
- UL-listed

APPLICATIONS

- Power generators
- Engines
- Sensors
- Motion control
- Off-road vehicles
- Earth-moving equipment
- Ships
- Mobile equipment
- Industrial machinery
- Telecommunications

FEATURES

- Conformity with European (CE) safety standards (DIN VDE 0627 and certified through TUV Product Service GmbH) in the approved insert arrangement
- Offered in shell styles: 3102A box mount and 3106A straight plug
- Intermateable with AIT, MIL-DTL-5015 and 97 styles
- Class IP67 protection when mated
- UL-listed file # E202200
- Pre-earth (ground contact) design
- First-mate/last-break capability

CREATE YOUR PART NUMBER USING THESE THREE STEPS

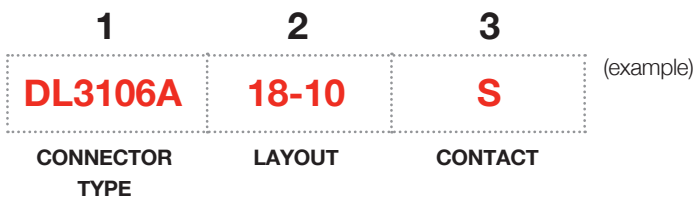

STEP 1: SELECT SHELL STYLE

PLUGS



DL3106A
Plug

RECEPTACLES

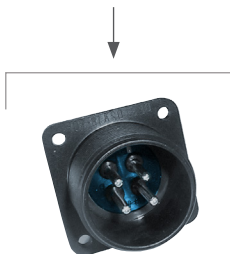

DL3102A
Box Mount Receptacle

STEP 2: SELECT LAYOUT

LAYOUT	MATING VIEW OF PIN INSERT	TOTAL CONTACTS	CURRENT RATING (AMPS)		
			13A	23A	46A
			CONTACT SIZE		
			16	12	8
10SL-3		3	3	-	-
18-10		4	-	4	-
18-12		6	6	-	-
20-15		7	-	7	-
22-22		4	-	-	4
24-106*		7	-	-	7
24-10		7	-	-	7

• Indicates Pre-Earth contact only

*Pre-Earth contact in plug

STEP 3: SELECT CONTACT

→ P = Pin S = Socket

MS3057-A CABLE CLAMP

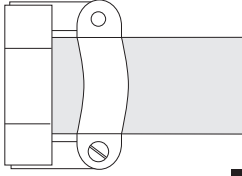

Standard MS3057 cable clamps have dual-clamping action to provide a balanced, positive hold on the wires and greatly reduce moisture transmission. This cable clamp accepts MS3420 bushings. MS3420 bushings can be nested to reduce the inside diameter (ID) to more closely match the diameter of the cable or wire bundle.

SHELL SIZE	THREAD CLASS 2B	STANDARD CLAMP				STANDARD CLAMP & TELESCOPIC BUSHING		
		LOW-COST CAST ZINC	ALUMINUM W/ BRASS SCREWS	ALUMINUM W/ STAINLESS STEEL SCREWS	MAXIMUM CABLE DIAMETER INCH (MM)	LOW-COST ZINC WITH BUSHING	BUSHING INCLUDED	BUSHING ID INCH (MM)
8S/10S	1/2-28UNEF	-	MS3057-3A	M85049/41-3A	0.250 (6.35)	-	MS3420-3	0.130 (3.3)
10SL	5/8-24UNEF	97-3057-1004**	MS3057-4A	M85049/41-4A	0.312 (7.92)	97-3057-1004-1	MS3420-4	0.220 (5.6)
12/12S	5/8-24UNEF	97-3057-1004**	MS3057-4A	M85049/41-4A	0.312 (7.92)	97-3057-1004-1	MS3420-4	0.220 (5.6)
12SL/14S	3/4-20UNEF	97-3057-1007**	MS3057-6A	M85049/41-6A	0.438 (11.10)	97-3057-1007-1	MS3420-6	0.312 (7.9)
16/16S	7/8-20UNEF	97-3057-1008**	MS3057-8A	M85049/41-8A	0.562 (14.27)	97-3057-1008-1	MS3420-8	0.437 (11.1)
18	1-20UNEF	97-3057-1010**	MS3057-10A	M85049/41-10A	0.625 (15.88)	97-3057-1010-1	MS3420-10	0.562 (14.3)
20/22	1 3/16-18UNEF	97-3057-1012**	MS3057-12A	M85049/41-12A	0.750 (19.05)	97-3057-1012-1	MS3420-12	0.625 (15.9)
24/28	1 7/16-18UNEF	97-3057-1016**	MS3057-16A	M85049/41-16A	0.938 (23.80)	97-3057-1016-1	MS3420-16, -12	0.625 (15.9)
32	1 3/4-18UNS	97-3057-1020**	MS3057-20A	M85049/41-20A	1.250 (31.75)	97-3057-1020-1	MS3420-20, -16	0.750 (19.1)
36	2-18UNS	97-3057-1024**	MS3057-24A	M85049/41-24A	1.375 (34.92)	97-3057-1024-1	MS3420-24, -20	0.937 (23.8)
40	2 1/4UNS-16	-	MS3057-28A	M85049/41-28A	1.625 (41.28)	-	-	-

Default plating is CAD OD.

** Other platings are available. → See page 17.

MS3057-C WATERPROOF CABLE CLAMP

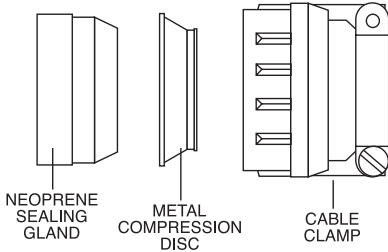

Standard MS3057-C waterproof cable clamp with mechanical strain relief for use with threaded endbells. Internal neoprene gland and compression ring will seal a broad range of round cable diameters, as listed below. For reduction of cable diameters, order the appropriate MS3420A bushing in table.

SHELL SIZE	PART NUMBER	WIRE DIAMETER INCHES (MM)		OPTIONAL BUSHINGS	
		MAX.	MIN.	PART NUMBER	MAX. WIRE DIA. (MM)
8S/10S	MS3057-3C	0.219 (5.56)	0.095 (2.41)	MS3420-3A	0.125 (3.17)
10SL/12S/12	MS3057-4C	0.312 (7.93)	0.188 (4.80)	MS3420-4A	0.219 (5.56)
12SL/14S	MS3057-6C	0.438 (11.12)	0.281 (7.10)	MS3420-6A	0.312 (7.93)
				MS3420-4A	0.219 (5.56)
16/16S	MS3057-8C	0.530 (13.48)	0.312 (7.90)	MS3420-8A	0.438 (11.1)
				MS3420-6A	0.312 (7.93)
18	MS3057-10C	0.625 (15.87)	0.375 (9.50)	MS3420-10A	0.438 (11.1)
				MS3420-6A	0.312 (7.93)
20/22	MS3057-12C	0.750 (19.00)	0.500 (12.70)	MS3420-12A	0.540 (13.74)
				MS3420-8A	0.438 (11.10)
24/28	MS3057-16C	0.940 (23.80)	0.625 (15.90)	MS3420-16A	0.750 (19.00)
				MS3420-12A	0.540 (13.74)
				MS3420-8A	0.438 (11.10)
32	MS3057-20C	1.250 (31.75)	0.921 (23.40)	MS3420-20A	0.938 (23.8)
				MS3420-16A	0.750 (19.00)
				MS3420-12A	0.540 (13.74)
36	MS3057-24C	1.380 (35.00)	1.00 (25.40)	MS3420-24A	1.12 (28.50)
				MS3420-18A	0.938 (23.80)
				MS3420-16A	0.750 (19.00)
40	MS3057-28C	1.620 (41.25)	1.25 (31.80)	MS3420-28A	1.25 (31.75)
				MS3420-20A	0.940 (23.80)
				MS3420-16A	0.750 (19.00)

All dimensions in inches (millimeters in parenthesis)

MS3420 TELESCOPING BUSHINGS

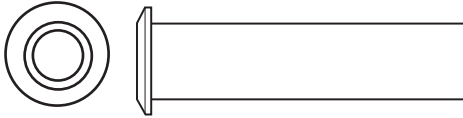

For use with style-A cable clamps and AIT/MS style-E/F endbells to resist dust, dirt, and oil. Bushings can be nested, one inside the other, to reduce the inside diameter to better seal against the cable jacket. Each bushing will accept the next smallest bushing.

SHELL SIZE	1ST BUSHING PART NUMBER	INSIDE DIAMETER	2ND NESTED BUSHING INSIDE	DIAMETER	FITS IN CABLE CLAMP
8S/10S	MS3420-3	0.130 (3.30)	NONE	-	MS3057-3A
10SL/12/12S	MS3420-4	0.220 (5.59)	NONE	-	MS3057-4A
14/14S	MS3420-6	0.312 (7.92)	NONE	-	MS3057-6A
16S	MS3420-8	0.437 (11.10)	NONE	-	MS3057-8A
16	MS3420-8	0.437 (11.10)	NONE	-	MS3057-8A
18	MS3420-10	0.562 (14.30)	NONE	-	MS3057-10A
20	MS3420-12	0.625 (15.90)	NONE	-	MS3057-12A
22	MS3420-12	0.625 (15.90)	NONE	-	MS3057-12A
24	MS3420-16	0.750 (19.05)	MS3420-12	0.625 (15.90)	MS3057-16A
28	MS3420-16	0.750 (19.05)	MS3420-12	0.625 (15.90)	MS3057-16A
32	MS3420-20	0.937 (23.80)	MS3420-16	0.750 (19.05)	MS3057-20A
36	MS3420-24	1.250 (31.75)	MS3420-20	0.937 (23.80)	MS3057-24A
40	MS3420-28	1.375 (34.92)	MS3420-24	1.250 (31.75)	SE96-28A4

MS3420-A REDUCTION BUSHINGS



For use with MS3057-C cable clamps (style-C) to reduce the wire-sealing diameter. Bushings can be nested, one inside the other, to progressively reduce the inside diameter of the cable clamp. The column labeled “reduction bushings” shows the acceptable nesting options for each clamp.



9767 CABLE CLAMPS

9767 waterproof cable clamp with mechanical strain relief. An internal Neoprene gland seal bushing and compression washer will seal a broad range of round cable diameters as listed below.

SHELL SIZE	CABLE CLAMP PART NUMBER	MAX. CABLE OUTSIDE DIAMETER		MIN. CABLE OUTSIDE DIAMETER		THREAD CLASS 2B UNEF
		INCHES	MM	INCHES	MM	
10SL/12S/12	9767-12-4	0.219	5.55	0.100	0.51	5/8-24
14S	9767-14-4	0.219	5.55	0.100	0.51	3/4-20
14S	9767-14-6	0.344	8.73	0.176	4.47	3/4-20
16S/16	9767-16-4	0.219	5.55	0.100	0.51	7/8-20
16S/16	9767-16-6	0.344	8.73	0.176	4.47	7/8-20
16S/16	9767-16-8	0.438	11.12	0.177	4.50	7/8-20
18	9767-18-6	0.344	8.73	0.176	4.47	1-20
18	9767-18-8	0.438	11.12	0.177	4.50	1-20
18	9767-18-10	0.563	14.29	0.292	7.42	1-20
20/22	9767-22-8	0.438	11.12	0.177	4.50	1-3/16-18
20/22	9767-22-10	0.563	14.29	0.292	7.42	1-3/16-18
20/22	9767-22-12	0.688	17.46	0.370	9.40	1-3/16-18
24/28	9767-28-10	0.563	14.29	0.292	7.42	1-7/16-18
24/28	9767-28-12	0.688	17.46	0.370	9.40	1-7/16-18
24/28	9767-28-16	0.844	21.43	0.536	13.61	1-7/16-18
32	9767-32-20	1.031	26.19	0.590	14.99	1-3/4-18UNS
36	9767-36-16	0.844	21.43	0.536	13.61	2-18UNS

All dimensions in inches (millimeters in parenthesis)

GASKETS

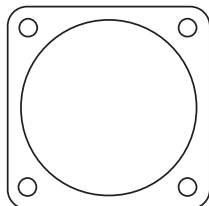

Synthetic rubber gaskets are used to ensure a moisture-tight seal between a receptacle and the panel. Gaskets are available for front or rear panel mounting of style-0, 2, and 6B connectors. Gasket thickness is approximately .031 inches (1 mm), for nonconductive and low-temperature types.

Conductive shielding gaskets contain an imbedded metal screen for EMI/RFI shielding in addition to moisture sealing. Gaskets are available for front or rear panel mounting of connectors. Gasket thickness is .020 inches (.5 mm).

SHELL SIZE	NON-CONDUCTIVE	CONDUCTIVE	LOW-TEMPERATURE -67°F (-55°C)
8S	10-040450-008	10-040450-08S	10-036675-008
10S/10SL	10-040450-010	10-040450-10S	10-036675-010
12/12S	10-040450-012	10-040450-12S	10-036675-012
14/14S	10-040450-014	10-040450-14S	10-036675-014
16S	10-040450-016	10-040450-16S	10-036675-016
16	10-040450-016	10-040450-16S	10-036675-016
18	10-040450-018	10-040450-18S	10-036675-018
20	10-040450-020	10-040450-20S	10-036675-020
22	10-040450-022	10-040450-22S	10-036675-022
24	10-040450-024	10-040450-24S	10-036675-024
28	10-040450-028	10-040450-28S	10-036675-028
32	10-040450-032	10-040450-32S	10-036675-032
36	10-040450-036	10-040450-36S	10-036675-036
40	10-040450-040	10-040450-40S	10-036675-040

METAL DUST CAPS WITH SASH CHAIN & DUMMY RECEPTACLES

Metal dust caps are used to protect the contacts when the connectors are left unmated. Dust caps come with metal chain lanyards. Dummy receptacles are for front or rear panel mounting. The center of the dummy receptacle is closed. Dummy receptacles mount on the same centers and have the same outside dimensions as MS3102 receptacles. A version with a clearance hole through the middle of the connector is also available. Call for ordering information; contact information is below.

SHELL SIZE	DUST CAPS		
	PLUG CAP	RECEPTACLE	DUMMY RECEPTACLES
8S	MS25042-8*	MS25043-8*	MS3105-8S
10S/10SL	MS25042-10*	MS25043-10*	MS3105-10S
12/12S/12SL	MS25042-12*	MS25043-12*	MS3105-12S
14S	MS25042-14*	MS25043-14*	MS3105-14S
16S	MS25042-16*	MS25043-16*	MS3105-16S
16	MS25042-16*	MS25043-16*	MS3105-16
18	MS25042-18*	MS25043-18*	MS3105-18
20	MS25042-20*	MS25043-20*	MS3105-20
22	MS25042-22*	MS25043-22*	MS3105-22
24	MS25042-24*	MS25043-24*	MS3105-24
28	MS25042-28*	MS25043-28*	MS3105-28
32	MS25042-32*	MS25043-32*	MS3105-32
36	MS25042-36*	MS25043-36*	MS3105-36
40	MS25042-40*	MS25043-40*	MS3105-40

*Contact us for other platings. *D = Olive drab chromate over cadmium DA = Anodized

SOLDER CONTACTS

STEP 1: Slide the rear accessories over the wire bundle in the proper sequence for re-assembly: cable clamp and/or endbell first, then ferrule and (if used) coupling nut.

STEP 2: Insert individual wires through the proper holes in the grommet. Use isopropyl alcohol as a lubricant.

STEP 3: Solder wires to appropriate contacts on the rear of the connector. Information on standard soldering practices is available upon request. Please contact us.

STEP 4: Fixture the connector for reassembly using the endbell assembly tools on [page 122](#).

STEP 5: Slide the grommet down the wires (lubricating the grommet with isopropyl alcohol will help).

STEP 6: Fill all unused grommet cavities with a wire hole filler to maintain the sealing integrity of the connector.

STEP 7: Slide coupling nut, ferrule, and endbell accessories over rear of the connector and tighten. For tooling, [see page 122](#).

CRIMP TOOL OPERATION

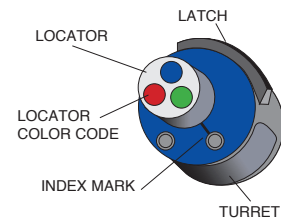
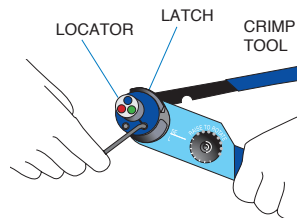
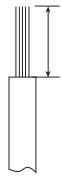

STEP 1: Strip the wires to the appropriate length. See strip lengths on the Contact Selection Guide, [page 30](#).

STEP 2: Open the crimp tool by squeezing the handles. Push the latch on the turret to release the locator. Attach the turret to the crimp tool using the two captive hex bolts in the turret.

STEP 3: Select the proper locator position for your contact by rotating the locator until the proper color is aligned with the index mark. Push locator back down until it snaps into position.

NOTE: Hand-crimp tools can be used with size 16S, 16 & 12 contacts. Size 8, 4 and 0 contacts require the use of air-powered crimp tools. Contact us for assistance in the use of these tools.

CONTACT SIZE	PIN LOCATOR COLOR	SOCKET LOCATOR COLOR
16S	Blue	Blue
16	Green	Red
12	Red	Red

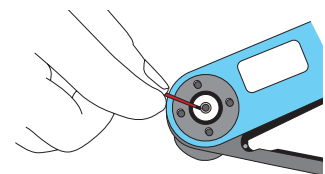
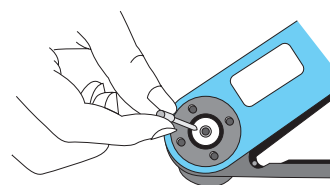
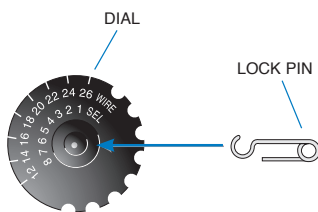

STEP 4: Adjust dial for proper wire gauge. To change the dial setting, remove the lock pin and lift center of dial. Turn to the desired wire gauge. Replace lock pin on dial.

STEP 5: Cycle the tool before inserting the contact to be sure the tool is in the open position. Drop the contact, mating end first, into the crimp cavity of the tool. Squeeze the tool handle just enough to grip the contact without actually crimping it.

STEP 6: Insert the stripped wire into the contact with a slight twisting motion. Be sure all wire strands are inside the contact. Squeeze the handle to cycle the tool. The handle will not release until the contact is completely crimped.

CRIMP TOOL OPERATION (CONTINUED)

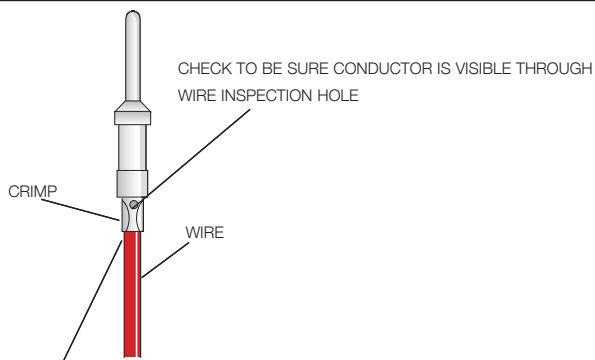

INSULATION SHOULD PRESS AGAINST THE END OF THE CONTACT.

STEP 7: Remove the crimped contact. Pull on the wire slightly to be sure it is properly crimped. Be sure the contact is not bent or damaged in any way. Visually inspect the crimp.

MICRO-SECTIONS: Enlargement of micro-section permits a final inspection of crimp quality. This test is recommended whenever new tools or new types of wire or contacts are used.

CRIMP TENSILE STRENGTH

Initial minimum pullout force in lbs. (before conditioning)

SIZE	WIRE GAUGE (AWG)	LB.
16	20	20
	18	40
	16	50
12	14	70
	12	110
8	8	185
4	4	450
0	0	800

INSERTION OF CONTACTS

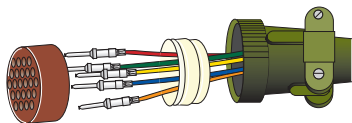

STEP 1: Slide the rear accessories over the wire bundle in the proper sequence for re-assembly: cable clamp and/or endbell first, then ferrule, and coupling nut.

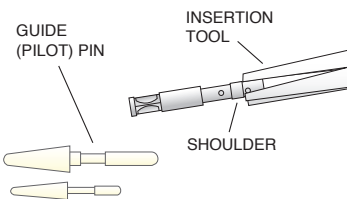

STEP 2: Use the proper insertion tool from the Contact Selection Chart on [page 31](#). Place the contact in the tool. The tool should push against the shoulder of the contact. Contact sizes 16S, 16, and 12 use a pliers-style tool. Contact sizes 8, 4 and 0 use a tool with a C-shaped shaft.

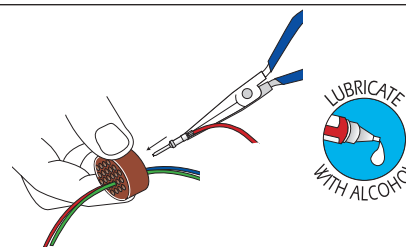

STEP 3: Lubricate the grommet with isopropyl alcohol (do not use any other type of lubricant). Insert the contact through the appropriate cavity in the grommet. Sizes 16S, 16 and 12 socket contacts must be installed using guide (pilot) pins. See the Contact Selection Guide on [page 31](#) for Insertion Guide (Pilot) Pin part numbers.

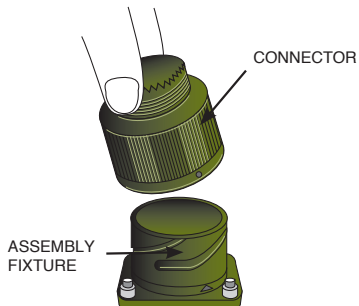

STEP 4: Place the connector into an assembly fixture. Fixtures are available for production use; contact us using the information below. If you are not using a fixture, be sure to allow clearance on the mating face of the connector for the guide pins to come through the connector during insertion.



STEP 5: Lubricate the contact cavities of the connector insulator with isopropyl alcohol (do not use any other type of lubricant).

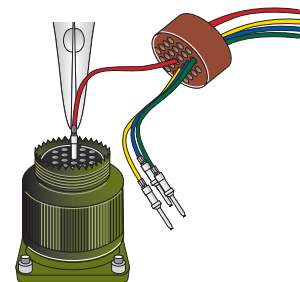

STEP 6: Using guide pins where necessary, push straight down with a firm, even pressure until the contact snaps into position in the proper cavity. Start at the center of the pattern and work toward the outer edges.

INSERTION OF CONTACTS (CONTINUED)

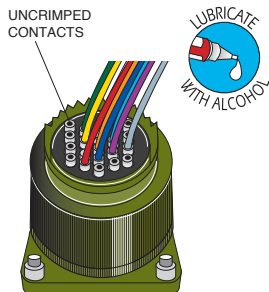

STEP 7: Fill any unused cavities with contacts.

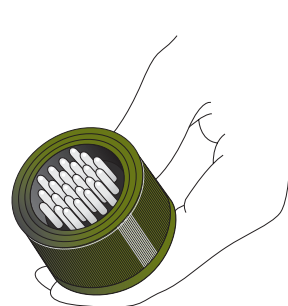

STEP 8: Check the mating face of the connector to ensure that all of the same size contacts are on the same plane (fully inserted). If not, the contact is not fully inserted. Remove the contact using the proper extraction tool and procedure, and reinsert. Do not attempt to reinsert the insertion tool to correct the problem.

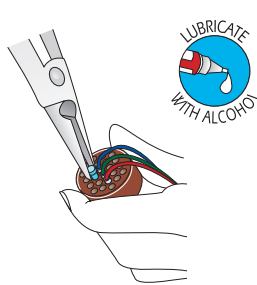

STEP 9: A wire hole filler must be inserted into the grommet behind the unused contacts to maintain the sealing integrity of the connector. See the Contact Selection Chart on [page 31](#) for wire hole fillers.

STEP 10: Place the connector back in the fixture for re-assembly. Slide the connector accessories back down the cable over the rear of the connector and tighten. Use the appropriate endbell tools as shown on [page 122](#).

EXTRACTION OF CONTACTS

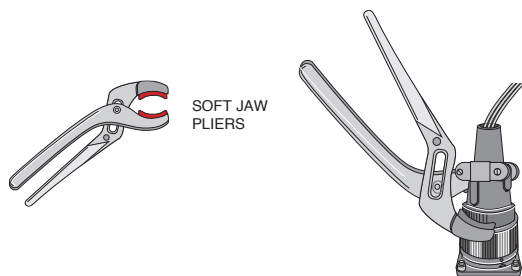

STEP 1: Remove the endbell accessories and slide them back over the wires. Use the appropriate endbell tools as shown on [page 122](#).

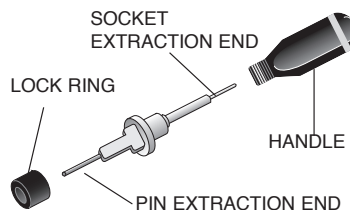

STEP 2: Use the proper extraction tool from the Contact Selection Chart on [page 31](#). The extraction tool can be used for both pin and socket contacts by removing the shaft from the handle and reversing it for pin or socket extraction.

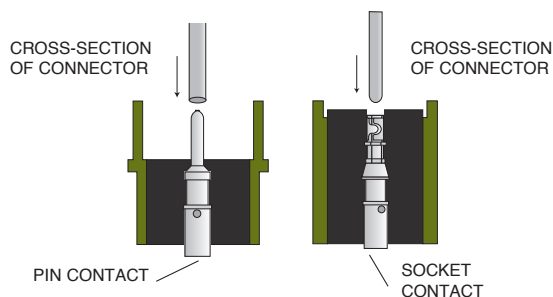

STEP 3: On the mating face of the connector, insert the tool over the pin contact or into the socket contact until the tool touches bottom. Apply a slow, continuous pressure to push the contact out through the rear of the connector. When the shoulder of the tool “thunks” against the insulator, the contact is extracted.

STEP 4: Carefully remove the extraction tool from the connector to avoid damage to the insulator.

AIT/MS SERIES CONNECTORS

J MS 3102 R 18-3 P W -RES

CONNECTOR TYPE

- J Prefix*
- MS Military Standard

(NOT J MS)

Modification for A-style service class only
RESilient insert (*neoprene*)

SHELL STYLE

- Mates with
- 3100 = Wall-mounting receptacle
 - 3101 = Cable-connecting receptacle (*plug†*)
 - 3102 = Box-mounting receptacle
- 3106 = Straight plug
 - 3108 = 90° plug

INSERT ROTATION

W, X, Y, and Z designate that the insert is rotated in its shell from normal position. No letter is required for normal (*no rotation*) position. See tables on → pages 83-93.

SERVICE CLASS

- A Solid shell, not MS qualified
- C Solid shell for pressurized applications
- E Environmentally-resistant
- F Environmentally-resistant with strain relief (*J MS part number only*)
- R Lightweight, environmentally-resistant (*J MS part number only; not available for 3108*)

CONTACT TYPES

- P Pin contact
- S Socket contact

† Note: The US military changed the designation from cable receptacle to plug in the MIL-DTL-5015 specifications.

SHELL SIZE & INSERT ARRANGEMENT

See tables on → pages 72-93.

√ Parts are the only MS-approved inserts.

For insert arrangements over 50 and shell size 40 and above. Exceptions: 36-52, 40-1, 40-9 and 40-56 are approved.

*The March 30, 2003 revision of MIL-DTL-5015H requires that the letters JAN or J be physically marked on the connector preceding the MS designator. This mark certifies that the connector meets specification. The United States Government has obtained Certificate and Registration Number 504,860 for the certification mark "JAN" and Registration Number 1,586,261 for the certification mark "J."

HAVE A UNIQUE REQUIREMENT?

Quick assembly of custom products is our specialty! Email us at sales@peigenesis.com or complete our online Technical Request at www.peigenesis.com/technical-support. To contact us by phone, please see the back cover for a complete listing of our branch offices and contact numbers.

AC SERIES CONNECTORS

Ordering example part number ACC06AF18-1SX-025 is shown as follows:

If part number incorporates a "B," see AIB/GT → page 119.

AC C 06 AF 18-1 S X - 025

SERIES

AC Designates Amphenol Industrial Series

CONTACT STYLE

C Designates crimp contacts
 S Designates solder contacts
 CL Designates crimp contacts with low-smoke, zero-halogen insert and grommets
 SL Designates solder contacts with low-smoke, zero-halogen insert and grommets

SHELL STYLE

Mates with

- 00 Wall-mounting receptacle
- 01 In-line receptacle
- 02 Box-mounting receptacle
- 06 Straight plug
- 08 90° plug

CONNECTOR CLASS

A General-duty, threaded backshell, cable clamp, no grommet
 AF General-duty, threaded backshell, cable clamp, no grommet
 CF General-duty, threaded backshell, gland-sealed cable clamp, no grommet (08 only)
 E General-duty, integral endbell with cable clamp, with grommet (08 not integral endbell)
 F General-duty, threaded backshell, cable clamp, with grommet
 LCFZ Long-threaded endbell, gland-sealed cable clamp, with grommet (06 only)
 PGA Environmental connector for jacketed cable
 PGR Environmental connector for jacketed cable
 R General-duty, threaded backshell, no cable clamp, with grommet (06 only)
 SB Shielded shrink boot endbell with grommet (06 only)

SHELL SIZE & LAYOUT

See layout availability on → pages 72-93.

PLATING MODIFICATION CODES

003 Olive drab cadmium plate finish
 023 Electroless nickel finish (RoHS with crimp only)
 024 Green zinc alloy finish
 025 Non-conductive black alloy finish (RoHS with crimp)
 027 Conductive black alloy finish (RoHS with crimp)
 G96 Black hard-coat anodize
 A24 .000035 gold/nickel on contacts
 116 Less pre-tinned solder cups (solder only)
 472 116 & 025 mod codes (RoHS)
 548 116 & 023 mod codes (RoHS)
 553 116 & 027 mod codes (RoHS)

ALTERNATE INSERT ROTATION

W, X, Y, and Z designate that the insert is rotated in its shell from a normal position. No letter required for normal (no rotation) position. See → pages 83-93.

CONTACT TYPE

P Pin contacts
 S Socket contacts
 R RADSOK (high-amperage) crimp socket contacts only for sizes 12, 8, 4, and 0