









Nozzle D8-0.4mm 1 PCS
3D Printer Parts Nozzle D8-0.4mm

MFR: 4004020046

3D PRINTING — CREALITY

3D PRINTING BRASS NOZZLE

Delicate workmanship | Smooth filament-pushing | Precise molding

 <p>International brass Better thermal conductivity higher hardness</p>	 <p>Narrow-nosed nozzle Chamfering Craft</p>
 <p>Smooth inner wall Without glitches</p>	 <p>Even filament-pushing No more and no less</p>
 <p>High-end Craft Excellent quality</p>	 <p>All Series Various models available</p>

|| BRASS NOZZLE

Nozzle anatomy

Name: Brass nozzle

Material: International brass

Size: 6mm*13mm

Compatible filament size:1.75

Compatible nozzle tip size: 0.1,0.2,0.3,0.4,0.5,0.6,0.8,1.0,1.2mm

1.75mm filament apply to nozzle of 2.0mm inner diameter

3.0mm filament apply to nozzle of 3.2mm inner diameter

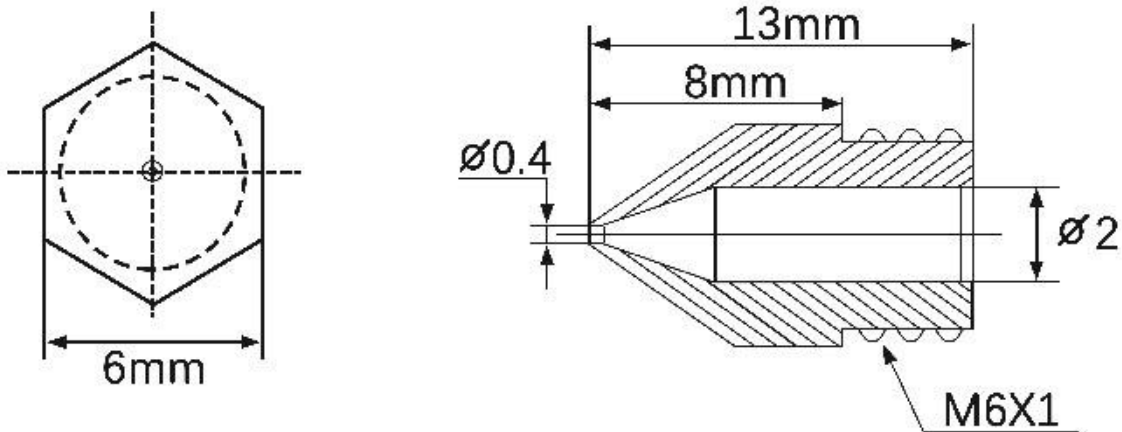

International brass craft Better thermal conductivity, higher hardness

Print better quality with excellent thermal conductivity and wear-resistant

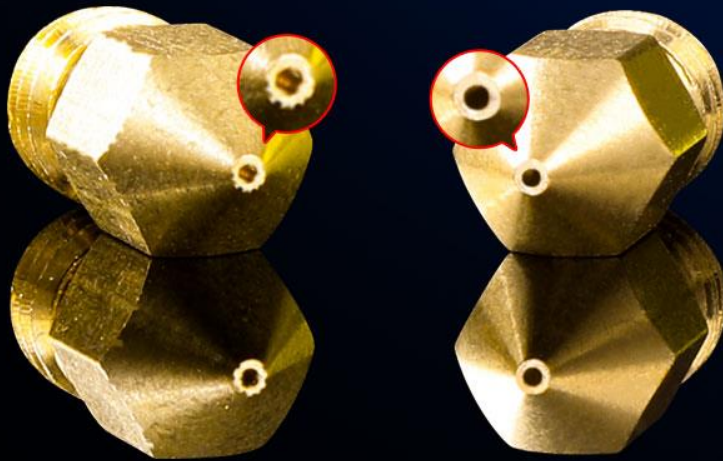

Common nozzle ❌

International brass nozzle ✅



VS



Most flaws is appeared if model printed with common nozzle

Smooth surface if model printed with international brass nozzle



Smooth inner wall without glitches Smoother filament–pushing

Smooth inner wall without glitches, low viscosity, and smoother filament–hopper
Meanwhile, the craft that the model printed with common nozzle is not mature enough
Rough inner wall and concave convex surface make filament come out unsmoothly

Smooth inner wall
smoother filament–pushing

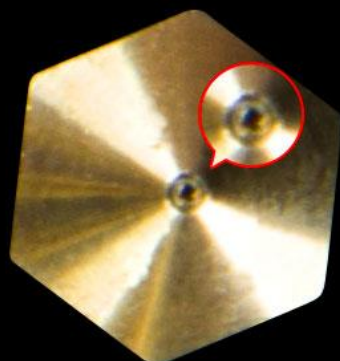
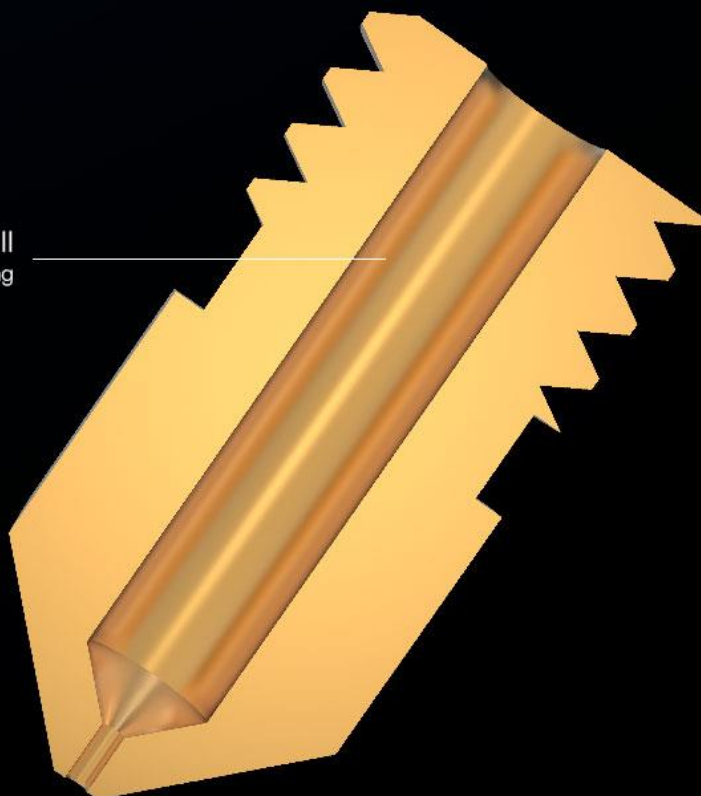

Common nozzle ❌

VS

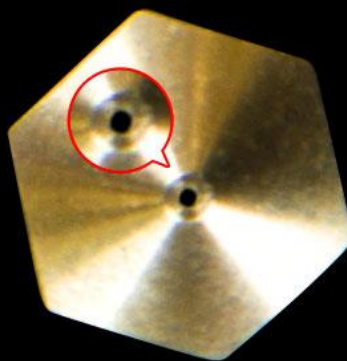

International brass nozzle ✅

Nose with chamfer Round nozzle

Chamfer craft and smooth surface reduce the resistance to filament
so that the filament come out smoothly, feed in easier
and rarely block the nozzle



Common nozzle ❌

International brass nozzle ✅

Seamless junction



Seamless junction prevents filament leakage from nozzle head

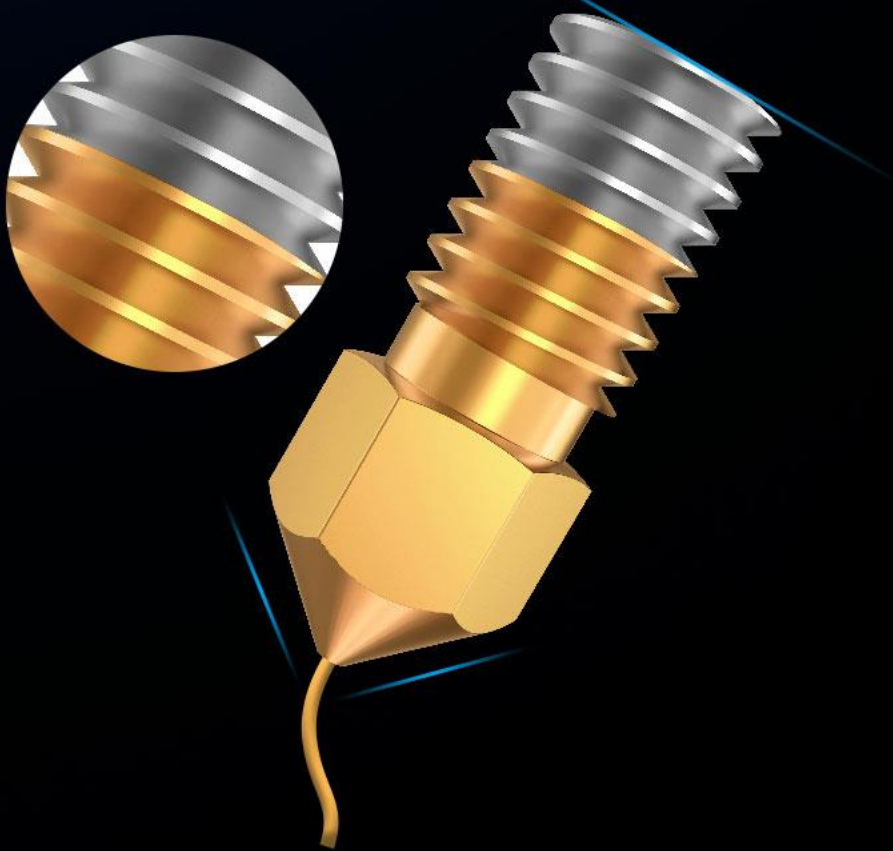

Better compatibility and applicability

The international brass nozzle can be used with most heating blocks such as E3D, mk8, etc

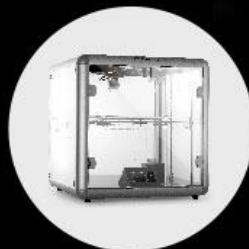

Product Picture

